



# **CE 200**

## **Details of Construction (Lab Manual)**



**Department of Civil Engineering**  
**Ahsanullah University of Science and Technology**

December, 2017

## **Preface**

Any construction process is done in a step by step, within a given schedule, whether it is a building, bridge or a tower. This is a task that needs sound planning, design, and field supervision. Different structural members, e.g., beam, column, etc and different structures e.g., building, bridge, etc. each demands specific construction procedure to be followed depending on the project, environment, time, etc. This lab handout covers some common structural members – their definition, types and typical construction steps. Although, undoubtedly, the title ‘Details of Construction’ actually refers to further detail description of construction process with its various alternatives. This should be viewed as an introductory resource to that large sphere of practical field knowledge.

This lab manual is prepared with the help of the renowned text book Building Construction by Shushil Kumar. Pictures from internet and from some presentations of the students of CE Department, AUST have also been used in describing different process.

**Munshi Galib Muktadir**

Department of Civil Engineering  
Ahsanullah University of Science and Technology

**Sadia Mohsin**

Department of Civil Engineering  
Ahsanullah University of Science and Technology

# Table of Contents

<b>Topic Name</b>	<b>Page No.</b>
1. Building.....	1
1.1 Types of buildings.....	1
1.2 Load Transfer Path.....	3
1.2.1 Load transfer paths in frame structure.....	4
1.3 Components of Building.....	7
1.4 Technical Terms.....	9
2. Foundation.....	11
2.1 Site Exploration.....	11
2.1.1 Methods of site exploration.....	11
2.2 Foundation.....	14
2.2.1 Strip/ Wall/ Continuous Footing.....	15
2.2.2 Individual/ Isolated Footing.....	15
2.2.3 Mat/ Raft Footing.....	19
2.2.4 Pile Foundation.....	24
3. Column,Beam and Slab.....	37
3.1 Column.....	37
3.1.1 Classification of column.....	37
3.1.2 Construction steps of column.....	38
3.1.3 Concrete casting.....	42
3.2 Beam.....	44
3.2.1 Classification of beam.....	44
3.2.2 Construction steps of beam.....	44
3.3 Slab.....	49

3.3.1 Classification of slab .....	49
3.3.2 Construction steps of slab.....	50
4. Brick Masonry .....	54
4.1 General features .....	54
4.2 Types of brick .....	55
4.3 Types of bonds in brick works .....	56
4.4 General Principles to be observed in brick masonry construction .....	57
4.5 Defects in brick masonry .....	57
4.6 Structural limitation of brick masonry .....	58
5. Stair .....	59
5.1 Technical Terms.....	59
5.2 Requirements of a Good Stair .....	62
5.3 Classification of Stair.....	64
6. Types of Joint.....	65
6.1 Construction Joint .....	65
6.2 Expansion Joint .....	66
6.2.1 Importance of Expansion joint .....	66
6.3 Contraction Joint .....	67
7. Shoring, Underpinning and Scaffolding .....	68
7.1 Shoring .....	68
7.2 Underpinning.....	69
7.3 Scaffolding .....	70
8. Details of Roof.....	71
8.1 Parapet.....	71
8.2 Rain Water Spouts.....	72
8.3 Stair Case .....	72

8.4 Roof Covering .....	72
8.5 Plumbing Lines .....	73
8.6 Lift machine room.....	73
8.7 Overhead Water Tank .....	73
8.7.1 Overhead water tank design calculation.....	74
8.8 Underground Water Tank .....	75
8.8.1 Underground Water Tank Design Calculation .....	75
9. Construction Materials.....	77
9.1 Concrete .....	77
9.2 Cement .....	78
9.3 Aggregate .....	78
9.3.1 Fine Aggregate .....	78
9.3.2 Coarse Aggregate .....	79
9.4 Brick.....	80
10. Mixing and Placing of Concrete .....	81
10.1 Concreting.....	81
10.2 Water-Cement Ratio.....	81
10.3 Equipment to Mix Concrete .....	82
10.3.1 Mixing Machine .....	83
10.3.2 Ready Mix Truck.....	83
11. Shuttering and Curing .....	85
11.1 Shuttering .....	85
11.2 Curing.....	86
11.2.1 Methods of Curing.....	86
12. Building Finishes and Building Services.....	87
12.1 Plastering.....	87

12.1.1 Types of Plaster .....	87
12.2 Pointing .....	87
12.3 White Wash.....	87
12.3.1 Application of White Wash.....	88
12.3.2 Purpose of White Wash.....	88
12.4 Paints.....	88
12.4.1 Types of Paints.....	88
12.5 Varnish.....	88
12.5.1 Types of Varnish .....	89
12.6 Sound Insulation/Sound Proofing/Acoustic Insulation.....	89
12.6.1 Commonly Used Method For Sound Insulation.....	89
12.7 Thermal Insulation .....	89
12.7.1 Importance of Thermal Insulation.....	90
13. House Plumbing.....	91
13.1 Plumbing System .....	91
13.1.1 Objective of Plumbing System.....	91
13.1.2 Plumbing Components .....	91
13.1.3 Types of Plumbing Joint.....	91
13.2 Types of Plumbing .....	93
13.2.1 Water Supply Plumbing .....	93
13.3 Drainage system.....	94
13.3.1 Types of Drainage System .....	94
13.3.1 Drainage Pipe Requirements .....	95
References.....	96

# 1. Building

A **building** is a structure with a roof and walls standing more or less permanently in one place, such as a house or factory. Buildings come in a variety of sizes, shapes and functions, and have been adapted throughout history for a wide number of factors, from building materials available, to weather conditions, to land prices, ground conditions, specific uses and aesthetic reasons. Buildings serve several needs of society – primarily as shelter from weather, security, living space, privacy, to store belongings, and to comfortably live and work. A building as a shelter represents a physical division of the human habitat (a place of comfort and safety) and the outside (a place that at times may be harsh and harmful).

## **1.1 Types of buildings**

Buildings can be classified into different categories from different perspective. Many buildings fall into multiple categories simultaneously. In general, building can be of following types:

- i. Residential Building
- ii. Educational Building
- iii. Institutional Building
- iv. Assembly Building
- v. Business Building
- vi. Mercantile Building
- vii. Industrial Building
- viii. Storage Building
- ix. Hazardous Building

**i. Residential Building:** This type includes the buildings for dwelling such as apartment houses, dormitories, hotels etc.

**ii. Educational Building:** The buildings those are used for school, college, day care purposes where group of people gathers fall into this category.

**iii. Institutional Building:** This type of buildings includes those where liberty of inmates is restricted. These buildings are for some specific purposes such as hospital, nursing homes, jails, orphanages etc.

**iv. Assembly Building:** The buildings or parts of building where groups of people gather for social, religious, civil, travel or amusement purposes can be classified as assembly building. Such buildings can be auditorium, exhibition halls, museum, gymnasium etc.

**v. Business Building:** These buildings are generally used for business transactions, keeping accounts, records etc. For instances, library, bank etc.

**vi. Mercantile Buildings:** This type of building is used for shop, malls, stationary where goods are stored and displayed for whole or retail sales purpose.

**vii. Industrial Building:** The buildings where fabrications, assembly, processing etc. of materials of all kinds take place are categorized as industrial building.

**viii. Storage Building:** These Building are used for storing goods or products such as ware house, cold storages, garages, grain elevators etc.

**ix. Hazardous Building:** The Buildings where highly combustible, explosive or toxic, corrosive or poisonous materials are stored are classified as hazardous building.



**Fig. 1.1** Residential building



**Fig. 1.2** Educational building



**Fig. 1.3** Institutional building



**Fig. 1.4** Assembly building



**Fig. 1.5** Business building



**Fig. 1.6** Mercantile building





**Fig. 1.7** Industrial building



**Fig. 1.8** Storage building



**Fig. 1.9** Hazardous building

### **Why types of buildings is a concern:**

1. To know the design load for the building
2. To know the best orientation of the building as per its purpose of use.

### **1.2 Load Transfer Path**

Load transfer path depends on the type of structure of the building.

Broadly, building structures can be of 2 types:

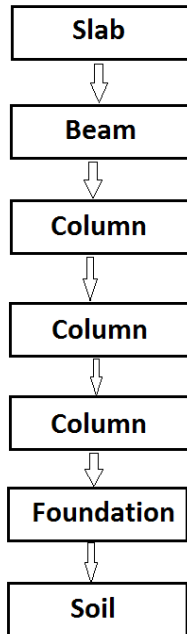
- i. Frame structure / Non-load bearing structure
- ii. Load bearing structure

**i. Frame structure:** Frame structure consists of slab, beam, column, foundation which bear all the loads of building. Here the walls of the building are usually for partition purpose, these partition walls do not take part in the load bearing mechanism of the building.

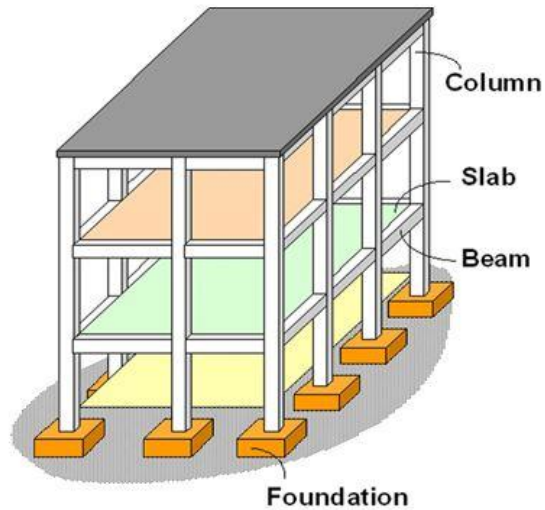
### 1.2.1 Load transfer paths in frame structure

#### Loads passing path for typical frame structure:

Typically in frame structures, load passes from slab to beam, beam to column and finally column to foundation.



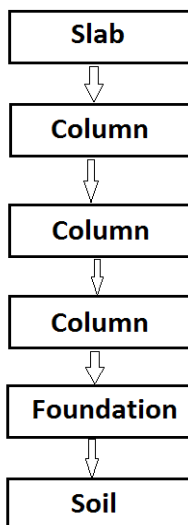
**Fig. 1.10** Typical load transfer path in Frame structure



**Fig. 1.11** Frame structure

#### Loads passing path for flat plate structure:

Load transfers directly from slab to column in case of flat plate or flat slab where no beams are constructed.



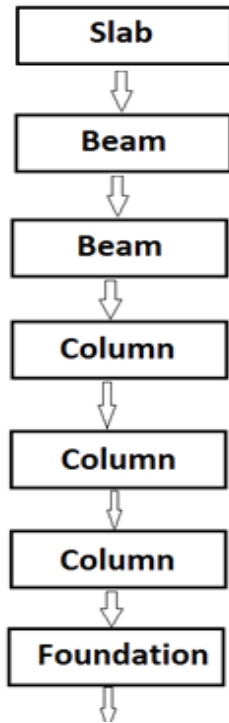
**Fig. 1.12** Load transfer path in flat plate structure



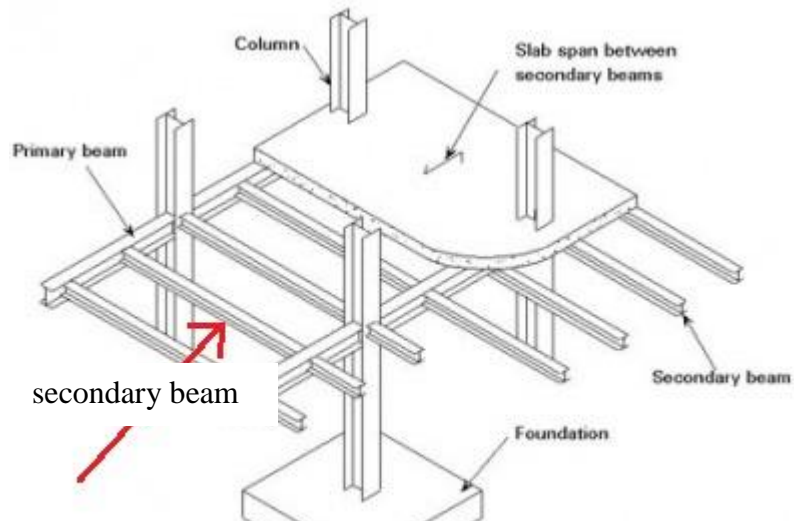
**Fig. 1.13** Flat plate structure

**Loads passing path for structure with secondary beam:**

This happens when a secondary beam is constructed between 2 primary beams. In this case, this secondary beam is not directly connected to any column.



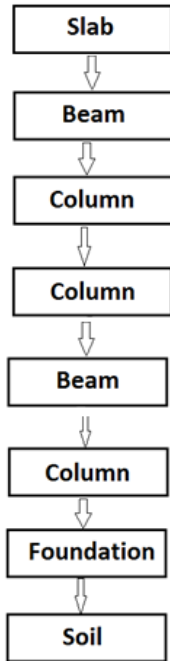
**Fig. 1.14** Load transfer path in frame structure with secondary beam



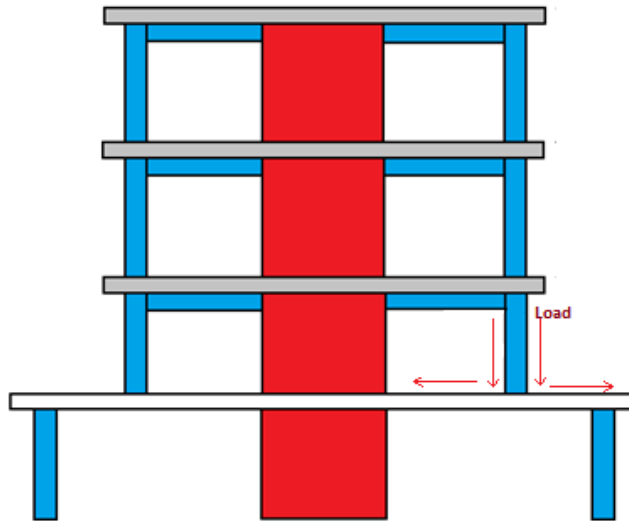
**Fig. 1.15** Frame structure with secondary beam

**Loads passing path for structure with deep beam:**

This occurs when some columns at basement are required to remove in order to make more space for vehicles to park or other purposes. The deep beam constructed at that level carries the load from column and transfers it to the remaining columns at base level.

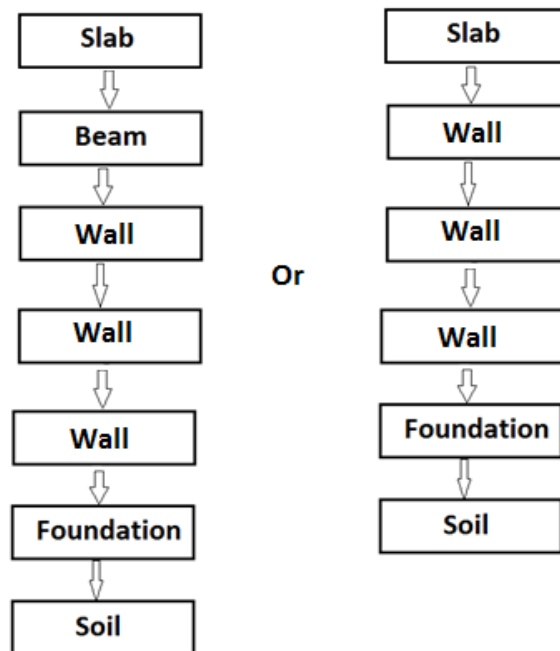


**Fig. 1.16** Load transfer path in frame structure with deep beam



**Fig. 1.17** Frame structure with deep beam

**ii. Load Bearing Structure:** In this structure, the walls of the building bear the load coming from the beam or directly from the slab and these walls subsequently transfer the load to the foundation.



**Fig. 1.18** Load transfer path in load bearing structure

### 1.3 Components of Building

Generally a building is divided in 2 major parts:

- i. Super structure
- ii. Sub structure

**i. Super structure:** This is the part of the building above the ground surface that is visible after the completion of the construction work. Example: Plinth, column, beam, slab etc.

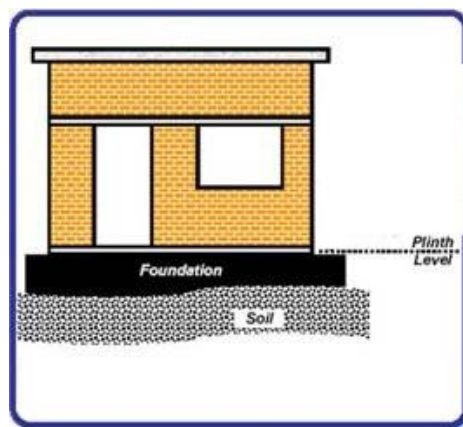
**ii. Sub structure:** This is the part of the building below the ground surface that is not visible after the completion of the construction work. Example: Foundation, shore pile etc.

In a broader sense, the components of a building can be classified as follows:

- Foundation
- Plinth
- Walls
- Beams
- Columns
- Floors
- Doors, Windows
- Stairs
- Roof
- Building finishes
- Building service

**Foundation:** Foundation transfers all kind of load coming from the super structure to the soil in such a way that it doesn't exceed the bearing capacity of the soil of that place.

**Plinth:** This is the floor of the building immediately above the ground surface. Plinth restricts the rain water or other materials from entering directly to the ground floor.



**Fig. 1.19** Plinth

**Walls:** In frame structure, walls are constructed for partition purpose, walls provide separation of floor spacing and also protect the inside space from sun, rain and other direct weathering effect. In load bearing structure, walls participate in load transfer procedure of the building.

**Beams:** Beams are horizontal members which take load coming parallel to its cross section. It can also take axial loads. Beams are mainly designed to resist bending.

**Columns:** Columns are vertical members that mainly take axial load (predominantly compression).

**Floors:** Floors are plane firm surface of slab which provides accommodation on a given plot. People stand on floors. Furniture, goods or other materials are kept or placed on floors.

**Doors, windows:** Door is the passage path through walls. It provides access to building, rooms etc.

Windows are the open parts of walls with transparent cover for the purpose of ventilation, light and vision.

**Stairs:** Stairs are connectors between one floor to the next floor. It consists of steps (tread, rise).

**Roof:** It is the top surface of the building which usually protects the building from rain, sun, light, snow etc.

**Building Finishes:** Building finishes make the building complete to live in, such as plastering, placing tiles/ mosaic, painting, white washing etc.



**Fig. 1.20** Building finishes

**Building services:** These are mainly the utility parts of a building such as water supply, electricity connection, gas connection, sanitation system etc.



**Fig. 1.21** Building services

## 1.4 Technical Terms

**Balcony:** Balcony is one kind of cantilever. It provides passage through different rooms. It also provides sitting out places.

**Basement:** It is the lower floors of the building which are below or partially below ground level.

**Sunshade:** It is an outside cantilever projection from the lintel that is situated above windows.

**Courtyard:** It is a place fully/partially surrounded by building and permanently open to sky.

**Damp Proof Course:** It is a course that consists of water proof materials used in different parts of building to prevent water penetration or dampness.

**Floor Area Ratio (FAR):** It is the ratio of “total covered area on all floors multiplied by 100” and “the area of total plot”

$$\text{FAR} = \frac{\text{Total covered area of all floors} \times 100}{\text{Total plot area}}$$

**Footing/ Foundation:** It is the lower part of the structure directly connected to soil to transmit loads to the ground/ soil without stressing the soil beyond its bearing capacity.

**Garage:** It is a building or portion of a building used for shelter, storage or parking of vehicles.

**Ground floor:** It is the floor that is nearest to the ground surface around the building.

**Parapet:** It is a low wall or railing built along the edge of a roof of a building.

**Partition wall:** It is the non-load bearing wall of the building which is used for partitioning the spaces of the floors.

**Porch:** It is a covered surface supported on pillars or otherwise for the purpose of pedestrian or vehicle approach to a building.

**Room height:** It is the vertical distance measured from the finished floor surface to the finished ceiling surface.

**Storey:** The portion of a building included between the surface of any floor and the surface of the floor next above it, or if there is no floor above it, then the space between any floor and ceiling next above it is called a storey.

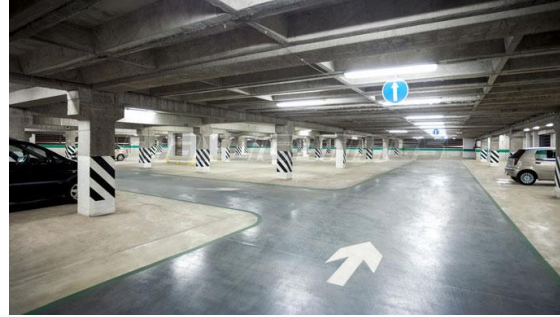
**Structural wall:** It is load bearing wall which carries the load of building along with its own weight.

**Cornice:** It is the slightly extra projected part of slab.

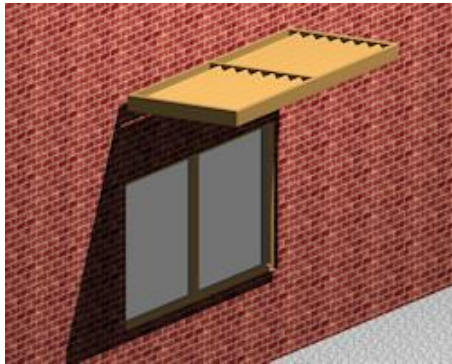
**Storey height:** It is the center to center distance between two consecutive slabs, or distance between floor of a slab to the next floor, or from one roof to the next roof.



**Fig. 1.22** Balcony



**Fig. 1.23** Basement



**Fig. 1.24** Sunshade



**Fig. 1.25** Courtyard



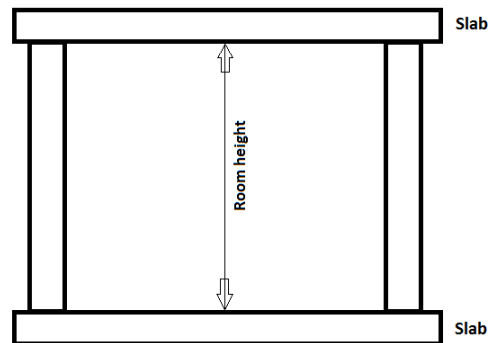
**Fig. 1.26** DPC



**Fig. 1.27** Parapet



**Fig. 1.28** Porch



**Fig. 1.29** Room height



## **2. Foundation**

### **2.1 Site Exploration**

As self weight and all other type of load that comes to a structure is finally transferred to the soil beneath it, the designer should have adequate information regarding the type and nature of soil available at different depths at the site for designing safe, sound and economical foundation for a structure. The aim is to get as much information about the physical properties and characteristics of the underlying material at site as well as details of other geological features of the area. All these attempts and activities are termed, in a broader sense, as ‘**Site Exploration**’.

More specifically, purposes of site exploration are:

- Determination of safe bearing capacity of soil.
- Selection of a safe and economical foundation type.
- Determination of depth of foundation.
- Prediction of the settlement of foundation.
- Locating ground water level.
- Forecasting the difficulties which are likely to be encountered due to nature of subsoil during construction.

#### **2.1.1 Methods of site exploration**

- i. **Test Pit**
- ii. Boring
  - a. Auger boring
  - b. Shell and auger boring
  - c. **Wash boring**
  - d. Percussion boring
  - e. Rotary boring
- iii. Probing
- iv. Subsurface sounding
- v. Geophysical method

#### **Test Pit:**

- The holes which are large enough to permit the entry of persons for inspection are called ‘Test pits’.
- Pits are square in plane and are dug by hand or by excavating equipment.
- In cohesion less soils the sides of the test pit are sharply sloped.
- In cohesive soils, at depth below 3m, bracing is required to keep the sides of the pit vertical.

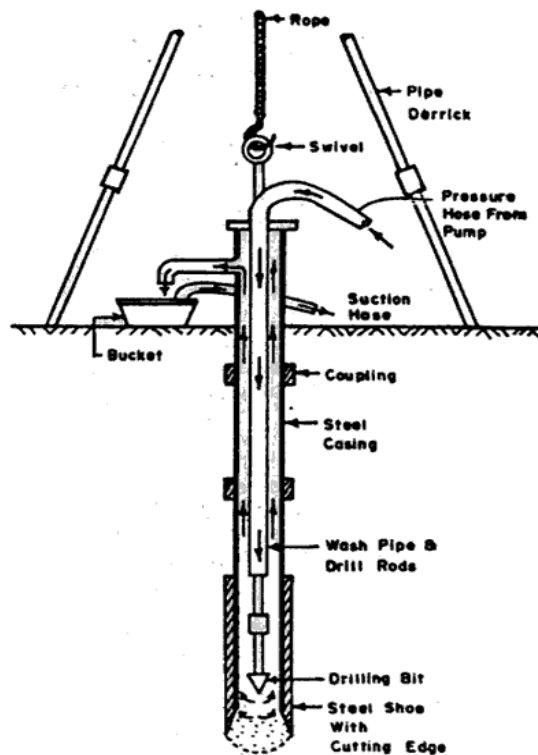
- Comparatively expensive thus used for structure having shallow foundations (up to 3 meters).



**Fig. 2.1** Test Pit

**Wash boring:**

- Step 01: Three legged pipe derrick is placed
- Step 02: Centering and Placing of Augur
- Step 03: Placement of temporary casing
- Step 04: Provision for water supply by hose pipe
- Step 05: Using bentonite



**Fig. 2.2** Wash boring



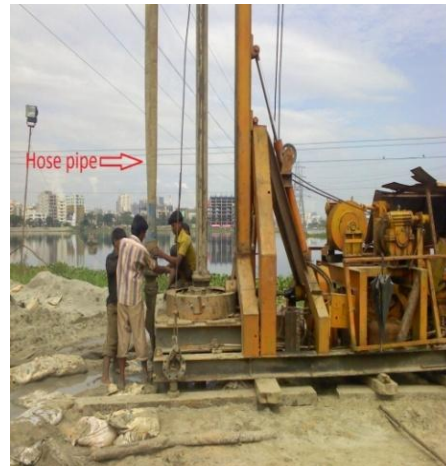
**Fig. 2.3** Placement of pipe derrick  
(step 01)



**Fig. 2.4** Centering and Placing of Augur  
(step 02)



**Fig. 2.5** Temporary casing placement  
(step 03)



**Fig. 2.6** Provision for hose pipe  
(step 04)



**Fig. 2.7** Using bentonite (step 05)

## 2.2 Foundation

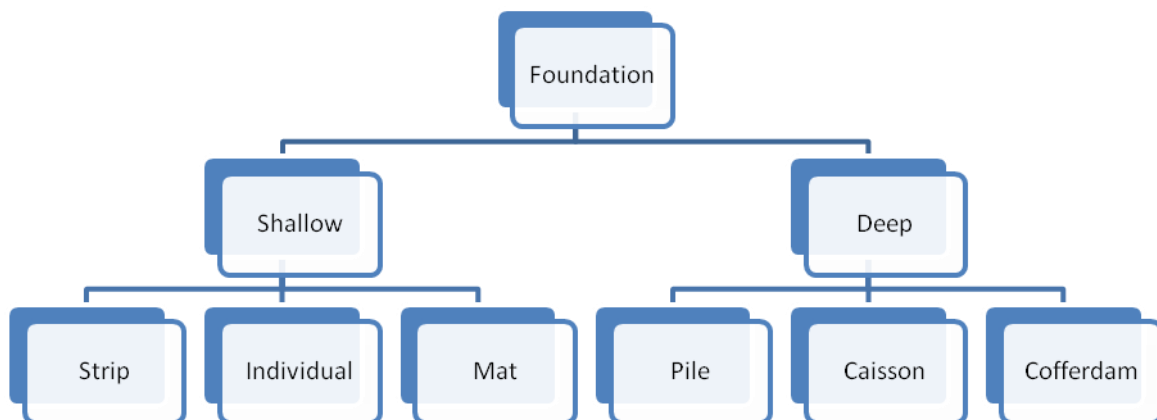
### About foundation

- It is the lowest part of a structure below ground level.
- Has direct contact with ground.
- It provides a base for the super-structure through the artificial arrangement of concrete block, piles, raft etc.
- It distributes the load of structure over a large area without stressing the soil beyond its capacity.

### Necessity of Foundation

- To distribute the weight of structure over a large area without stressing the soil beyond its capacity.
- To load the sub-stratum evenly and prevent unequal settlement or differential settlement.
- To provide a level surface that facilitates subsequent construction works.
- To take the structure deep into the ground and thus increase its stability by preventing overturning.

### Types of Foundation



### 2.2.1 Strip/ Wall/ Continuous Footing

This type of foundation is used under structure with load bearing wall.

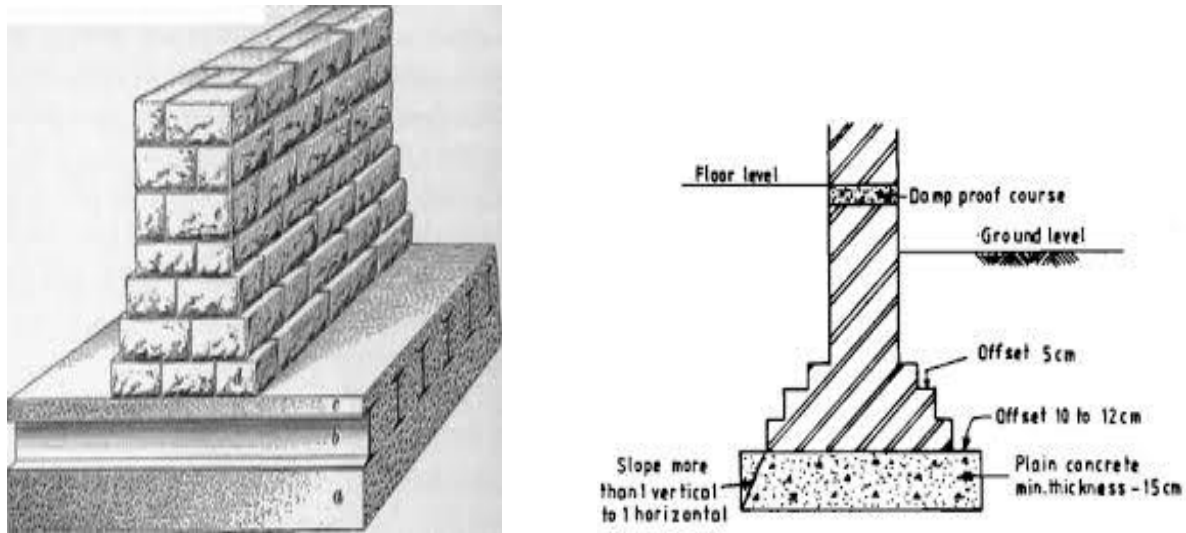


Fig. 2.8 Strip footing

### 2.2.2 Individual/ Isolated Footing

This type of foundation is used under structure with columns. This foundation is of two types:

- a. single footing and
- b. combined footing

#### a. Single Footing:

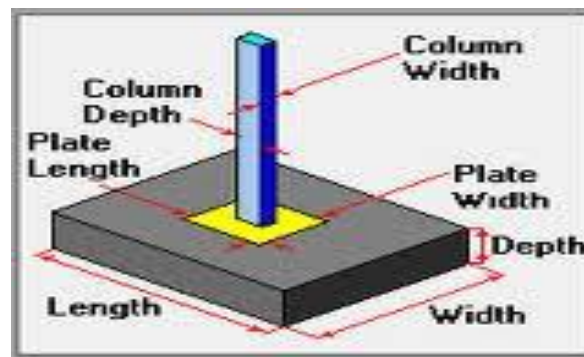


Fig. 2.9 Single footing

## Construction steps of a single footing:

- Step 01: Excavation of trench
- Step 02: Leveling and dressing
- Step 03: Brick Flat Soling (BFS) placement
- Step 04: Cement Concrete (CC) layer placement
- Step 05: Shuttering/ formwork (must be leak proof) placement
- Step 06: C.C. block (to maintain clear cover) placement
- Step 07: Rebar Placement
- Step 08: Casting of Concrete, C:FA:CA=1:1.5:3/1:2:4, w/c ratio=0.42-0.5
- Step 09: Compaction (to avoid segregation)
- Step 10: Removal of shuttering
- Step 11: Curing
- Step 12: Backfilling



**Fig. 2.10** Excavation of trench  
(step 01)



**Fig. 2.11** Leveling and dressing  
(step 02)



**Fig. 2.12** Brick flat soling placement  
(step 03)



**Fig. 2.13** Shuttering placement  
(step 05)



**Fig. 2.14** C.C. block placement  
(step 06)



**Fig. 2.15** reinforcement placement  
(step 07)



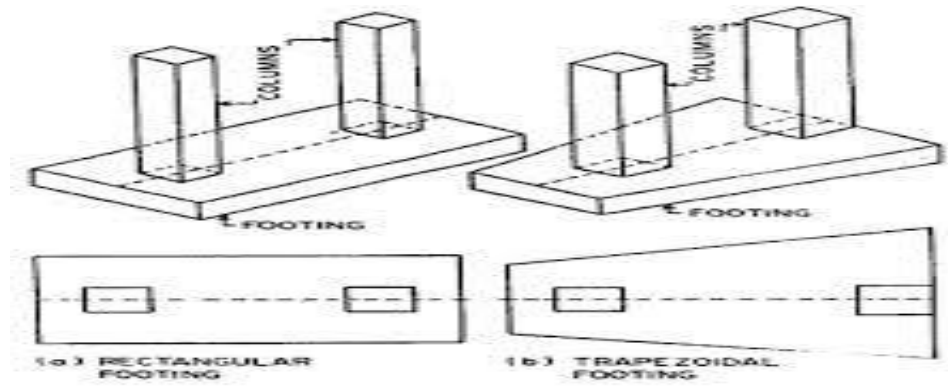
**Fig. 2.16** Casting of concrete  
(step 08)

**Fig. 2.17** Compaction of concrete  
(step 09)



**Fig. 2.18** Curing of concrete  
(step 11)

## b. Combined Footing:



**Fig. 2.19** Combined foundation

Combined footings are provided when:

- Two internal columns are so close that the two isolated footings overlap.
- Space outside the external column is limited by property line.
- Bearing capacity of soil is too low.

For a combined footing:

- $\text{Area of footing} = \frac{\text{Total Load}}{\text{Allowable Bearing Capacity of soil}}$
- Center of gravity of footing must coincide with center of gravity of load.



### 2.2.3 Mat/ Raft Footing

#### When Required

- When foundation area cover 50-60% of the total plot area (i.e. when bearing capacity is too low)
- Basement needed



**Fig. 2.20** Mat foundation

#### Advantages:

- Greater space (basement)
- Reduce differential settlement

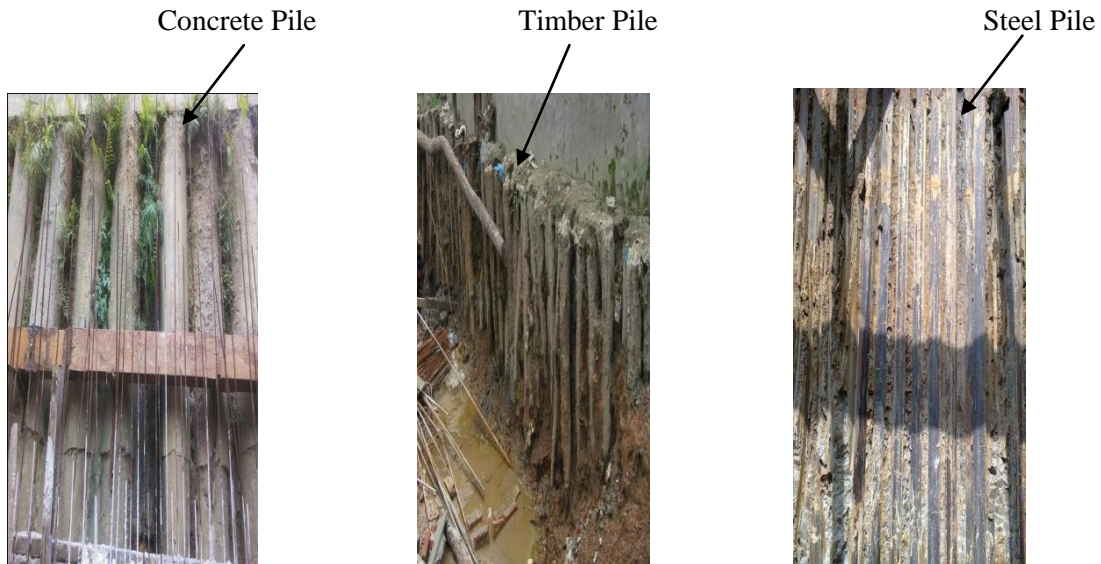
#### Disadvantages:

- Costly
- Shore protection is needed
- During construction ground water level may rise, which may cause the loss of contact with soil.
- Water may seep inside
- When raft thickness is high, problem may arise due to heat differences.

#### **Construction steps of a mat footing:**

- Step 01: Leveling
  - To provide an accurate networks of height
- Step 02: Shoring
  - Shoring is the process of supporting an unsafe structure by building a temporary structure.
  - Shoring is commonly used before installing the foundation.

- Supports the surrounding loads until the underground levels of the building are constructed
- To protect from shear failure of soil.
- Can be of 3 types: Concrete pile shore, steel sheet shore and timber shore.



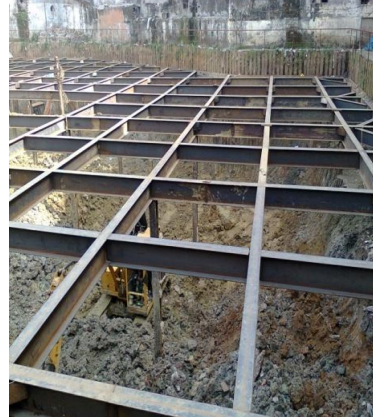
**Fig. 2.21** Different types of shore pile

- Step 03: Soil Excavation



**Fig. 2.22** Soil Excavation

- Step 04: Providing Strutting and Bracing



**Fig. 2.23** Strutting and bracing

- Step 05: Compaction and Leveling of Soil



**Fig. 2.24** Leveling



**Fig. 2.25** Sand Layer



**Fig. 2.26** Compaction

- Step 06: Provide Polythene, BFS, CC Layer



**Fig. 2.27** Polythene



**Fig. 2.28** CC layer



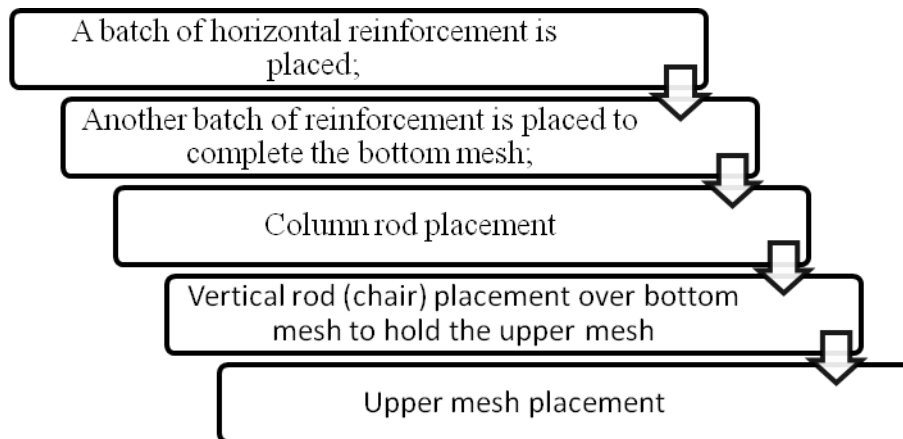
**Fig. 2.29** Leveler

- Step 07: Placing CC block beneath bottom layer reinforcement



**Fig. 2.30** Placing CC block

- Step 08: Placing of Reinforcement



**Fig. 2.31** Reinforcement placing  
(Bottom mesh)



**Fig. 2.32** Reinforcement placing  
(Top mesh)

- Step 09: Concreting



**Fig. 2.33** Concrete casting

- Step 10: Vibrating



**Fig. 2.34** Concrete compaction

- Step 11: Leveling



**Fig. 2.35** Leveling

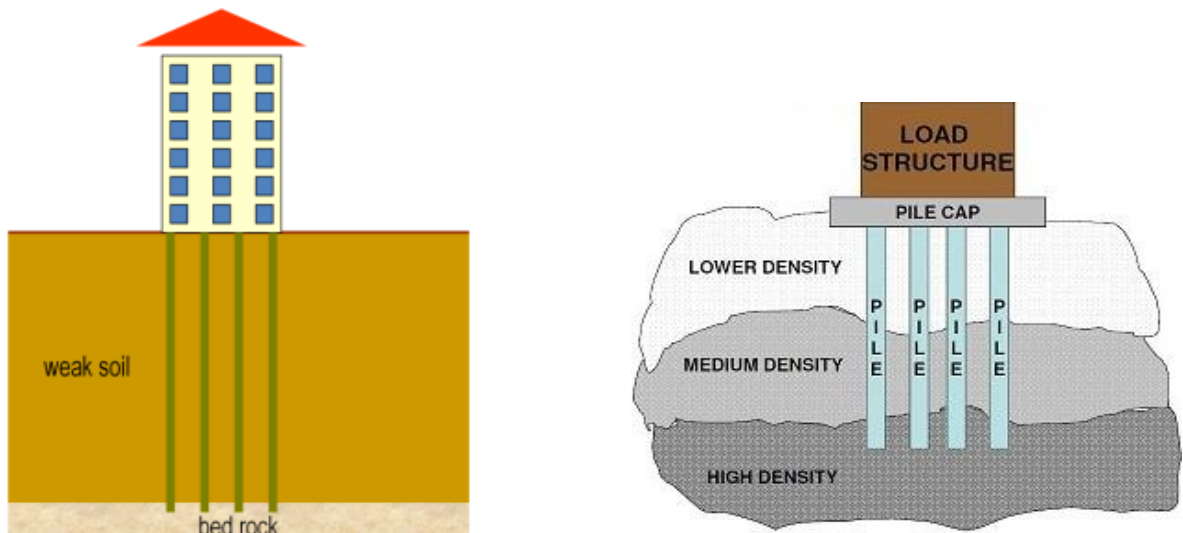
- Step 12: Curing



**Fig. 2.33** Concrete curing

### 2.2.4 Pile Foundation

A pile is a long slender foundation member, made either of timber, structural steel or concrete which might be cast-in-situ or driven and acts as a structural member to transfer the load of the structure to a required depth in deep foundations carrying a load which may be vertical or lateral or lateral plus vertical.



**Fig. 2.34** Pile foundation

Pile foundation is generally used when:

- Single or combined foundation at a suitable depth is not possible.
- The stratum of required bearing capacity is at a greater depth.
- Structure is situated on the sea shore or river bed, where there is danger of scouring action of water.
- Steep slopes are encountered.
- In compressible soil or water-logged soil or soil of made-up type.

Piles are used for foundation of building, trestles, bridges and water front installation .In general, pile foundation provides a common solution to all difficult foundation site problem.

### Types of Pile

#### A. Function wise

1. Bearing pile
2. Friction pile
3. Shore/sheet pile
4. Anchor pile
5. Batter pile
6. Fender pile
7. Compaction pile

#### B. Material wise

1. Timber pile
2. Sheet pile
3. Concrete pile
4. Composite pile

#### Bearing pile:

Here, End bearing capacity > Skin friction

#### Friction Pile:

Here, Skin friction > End bearing capacity

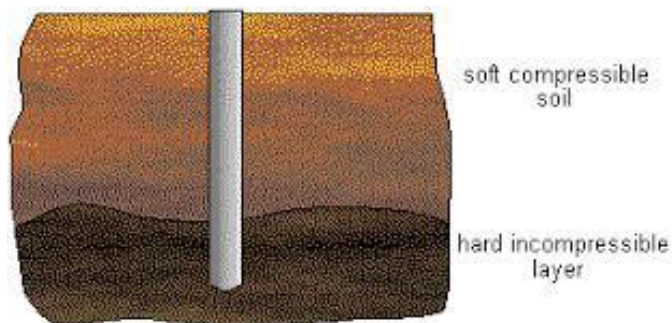


Fig. 2.35 Bearing pile

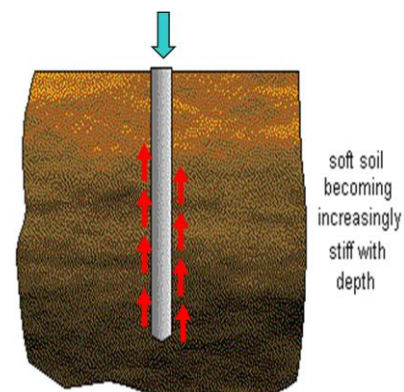


Fig. 2.36 Friction pile

**Timber Pile:**

When a timber column is installed vertically in the ground to at least 4m depth below the ground surface in order to bear load then it is called Timber Pile.

**Advantages:**

- Comparatively low cost and available
- As its length isn't long enough so it can be driven rapidly
- In comparison to concrete and steel pile it is more elastic
- No heavy machinery is required for this pile construction/ driving

**Disadvantage:**

- Its length is limited to some extent
- Its bearing capacity is comparatively low than the others
- It is vulnerable to seasoning in dry and wet seasons
- As it is an organic material, it can be attacked by insects and can be decayed by salt
- Its strength isn't high enough, so might be damaged while driving in soil

**Steel Pile:**

When a long slender column of steel is driven into the ground to carry a vertical load then it is called Steel Pile.

**Advantages :**

- As the cross-sectional area is very small, steel pile doesn't cause much soil displacement while being driven into the soil
- As the cross-sectional area is small and as steel is of high strength, steel pile can penetrate through rock and many hard substratum while being driven into soil.

**Disadvantage :**

- To avoid corrosion, the surface of the steel pile should be coated with coal tar or some other type of coating to prevent this corrosion.





**Fig. 2.37** Timber pile



**Fig. 2.38** Steel pile

### **Concrete Pile:**



**Fig. 2.39** Concrete pile

### **Advantages:**

- It is not responsive to GWT, so it is durable
- It can be given any shape or length that is required
- In comparison to timber pile, its bearing capacity is high. As a result, total number of pile required is less
- It is non-corrosive unlike steel pile
- The construction materials for concrete (cement, sand, aggregate etc.) are available almost everywhere

### **Disadvantages:**

- It is costly than timber piles
- Expensive reinforcement is required to bear the handling stress
- Elaborate technical supervision and heavy driving machine is required
- Precast pile needs more carrying cost and space to be worked on

## Types of Concrete Pile

- i. Pre-cast Pile (Driven Pile)
- i. Cast-in situ Pile (Bored Pile)
- ii. Prestressed Concrete Pile

### i. Pre-cast piles (Driven Piles):

The precast concrete pile is a prefabricated, high-strength concrete column, impact driven into the soil by means of an adjustable hydraulic or diesel hammer

#### Application Field:

- As it can ensure full strength by proper maintaining, so this pile is used for heavy weight structure
- As it is prefabricated, it can be used for under water construction

#### Shape:

- Circular
- Square
- Octagonal

## Construction Steps of Precast Pile

- **Step 01:** Constructing reinforcement casing consisting of main bar and ties/stirrups
- **Step02:** Placing of CC blocks to maintain clear cover
- **Step 03:** Placing of Shuttering
- **Step 04:** Inserting steel-cap for the sharp edge at the driving end.
- **Step 05:** Casting of concrete
- **Step 06:** Compacting / Vibrating
- **Step 07:** Leveling the top surface
- **Step 08:** Curing



**Fig. 2.40** Reinforcement casing construction (step 01)



**Fig. 2.41** Placing of shuttering (step 03)



**Fig. 2.42** Inserting steel cap (step 04)



**Fig. 2.43** Casting of concrete (step 05)



**Fig. 2.44** Compaction of concrete  
(step 06)



**Fig. 2.45** Leveling top surface  
(step 07)



**Fig. 2.46** Curing of concrete  
(step 08)

### **Advantages of Pre-cast Pile:**

- They can be cast well before the commencement of the work resulting in rapid progress of work.
- Their construction can be well supervised and any defect detected can be rectified before use.
- Their reinforcement remains in their proper position and do not get displaced.
- They can be driven under water.
- They can be loaded soon after they have been driven into the desired path.

### **Disadvantages of Pre-cast Pile:**

- They are heavy and great difficulties experienced for their handling and transporting.
- They are subjected to the driven shocks after the concrete has set. This may result in unsound construction.
- Pre-cast pile cannot be much longer in length.
- Pre-cast pile driving creates shock that can harm other structures.

### **Pile Driving**

Pile can be driven by 4 processes:

1. By Drop Hammer
2. By Steam Hammer
3. By Water Jets
4. By Borig

### **ii. Cast-In-Situ Piles (Bored Piles):**

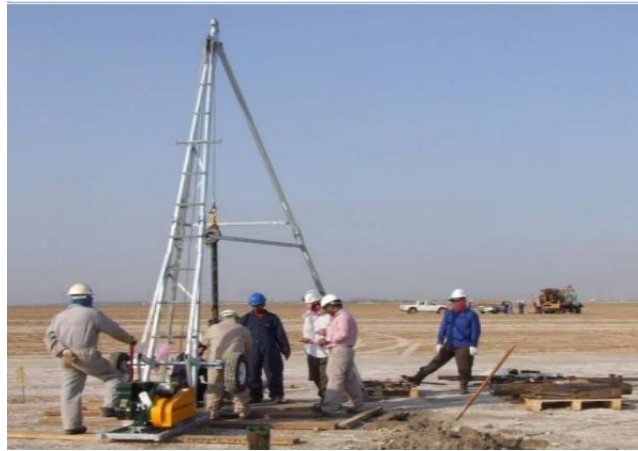
In case of cast-in-situ piles, a borehole is made by wash boring or other suitable methods, reinforcement casing is placed inside the borehole and finally fresh concrete is poured inside the hole, thus the pile is casted where it will stay for its lifetime.

## Construction Steps of Cast-In-Situ Pile

### Step 01: Wash Boring

#### (i) Three legged pipe derrick placing:

First, on the ground a three legged pipe derrick is place which holds.



**Fig. 2.47** Derrick Placing

#### (ii) Centering and Placing of Auger:

After placing the pipe derrick a circular shape (with conical sharp peak) auger is placed with the pipe derrick to loose the soil.



**Fig. 2.48** Centering and Placing of Auger

#### (iii) Temporary casing/Drive pipe inserting:

After digging for some depth a hollow steel pipe is inserted into the hole for a certain depth so that soil pressure coming from the lateral side of the hole cannot collapse soil into the hole.



**Fig. 2.49** Temporary Casing insertion

**(iv) Water (bentonite) supply by hose pipe:**

A pipe is usually lowered into the casing pipe to supply water (bentonite slurry) into the hole to loose the material of the bottom of the hole. This pipe is named wash jet pipe or wash pipe or hose pipe. The upper end of the pipe is connected to a water (bentonite slurry) supply source which supplies water (bentonite slurry).



**Fig. 2.50** Provision for hose pipe

**(v) Using Bentonite:**

Bentonite is used with water to make the water dense so that this water can withstand the pressure of the soil at gradual greater depth. Bentonite is recycled for reuse.



**Fig. 2.51** Using Bentonite

**Step 02: Construction of reinforcement casing consisting of stirrups and main rod**

- Bending of stirrups
- Reinforcement cutting
- Making spiral rod for reinforcement
- Placing the rod horizontally
- Placing circular CC block peripherally to maintain clear cover
- Placing the reinforcement in the hole



**Fig. 2.52** Reinforcement casing placing



### **Step 03: Welding**

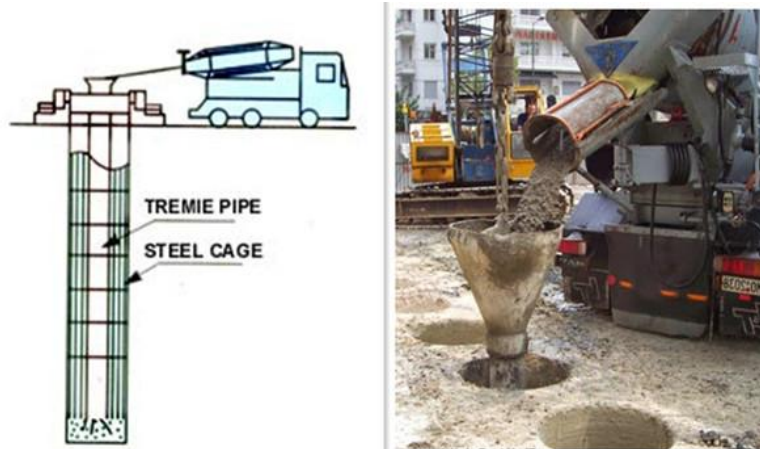
When another casing is required to insert then its bottom end is welded with the top end of the inserted casing



**Fig. 2.53** Welding of casings

### **Step 04: Casting Concrete using Tremie pipe**

A pipe is then inserted up to the bottom of the hole, then concrete is being cast through the large funnel shape cup.



**Fig. 2.54** Concrete casting by tremie pipe

### **Step 05: Vibrating**

The tremie pipe is at a time being up and down, shaken and vibrated to ensure the proper compaction

**Step 06: Curing**

After filling up the hole with concrete, then it is cured for about 28 days

**Step 07: Removing the impure concrete from the top**

After curing, the top part of each pile which is made of impure concrete is removed.

**Step 08: Pile cap construction**

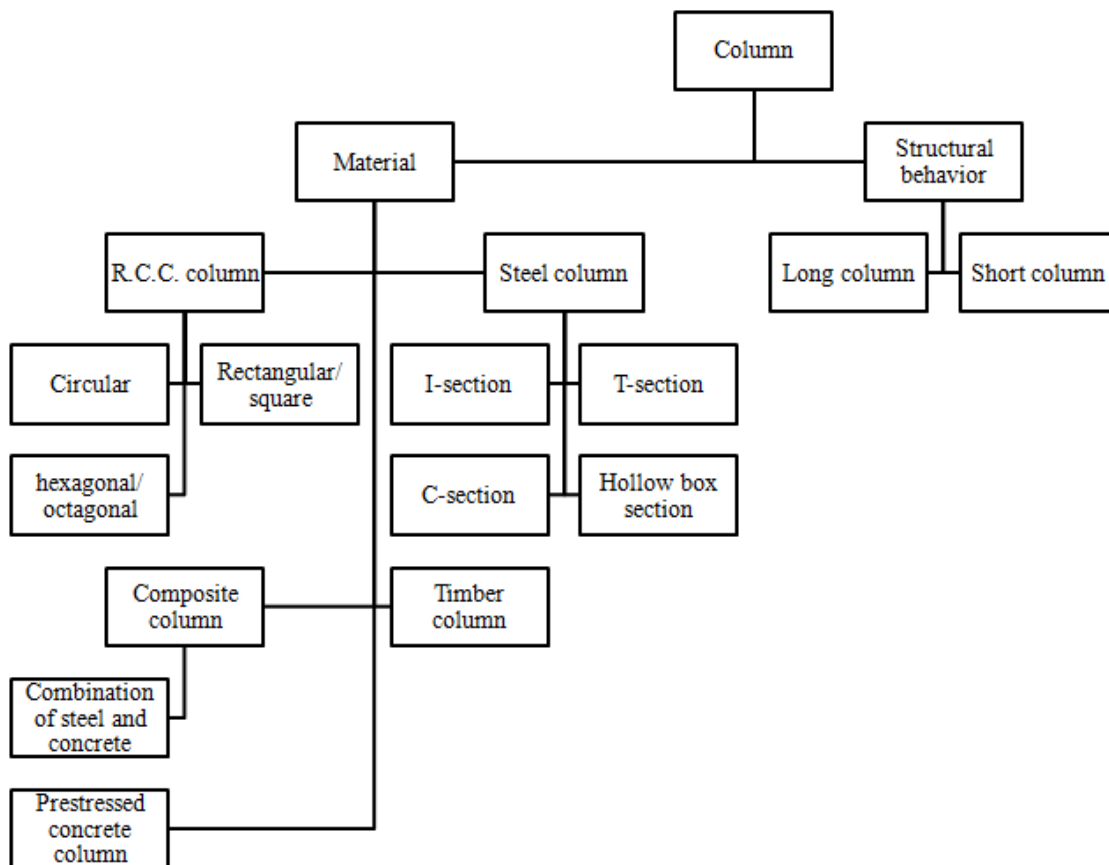
After removing the impure concrete, the upper part of the rods will be exposed. These rods are connected with pile cap rods and the casting of pile cap occurs.

## 3. Column, Beam and Slab

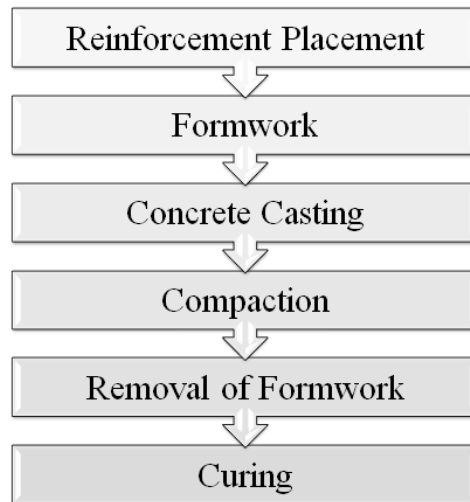
### 3.1 Column

- Structural member that predominantly takes axial load (predominantly compression).
- Column may need to take shear force and bending moment as well.
- It is the most important structural member from load carrying point of view.
- Should be given importance in analysis, design and construction stages.

#### 3.1.1 Classification of column



### 3.1.2 Construction steps of column



#### Main vertical reinforcement placement

- Column is casted directly over the footing
- It is then continued maintaining vertical alignment



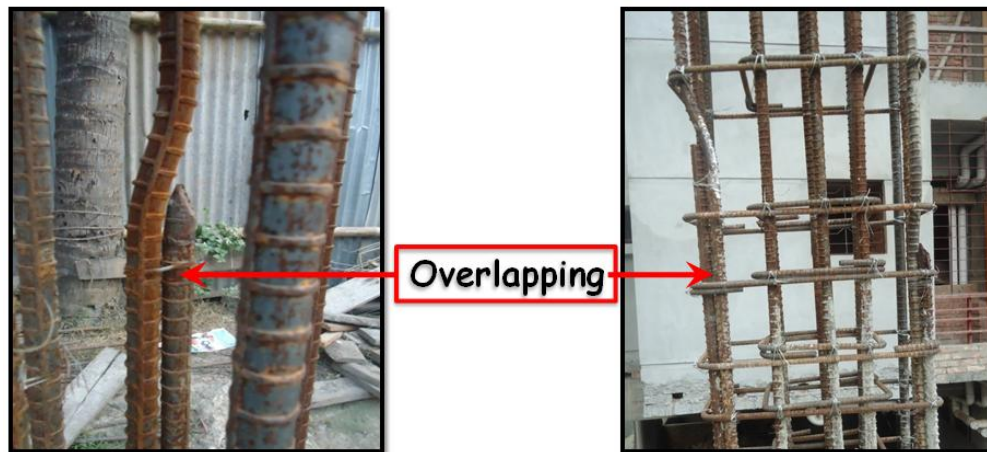
**Fig. 3.1** Placing column reinforcement

#### Main vertical reinforcement requirement

- Minimum 4 main bar (rectangular column)
- Minimum 6 main bar (circular column)

### Overlapping/ Splicing of Rods

- Provided mainly in the mid span
- Overlapped in sufficient amount to transfer load
- Tied with wires
- Not all rods are spliced at same level
- Avoided near support



**Fig. 3.2** Splicing of main rod

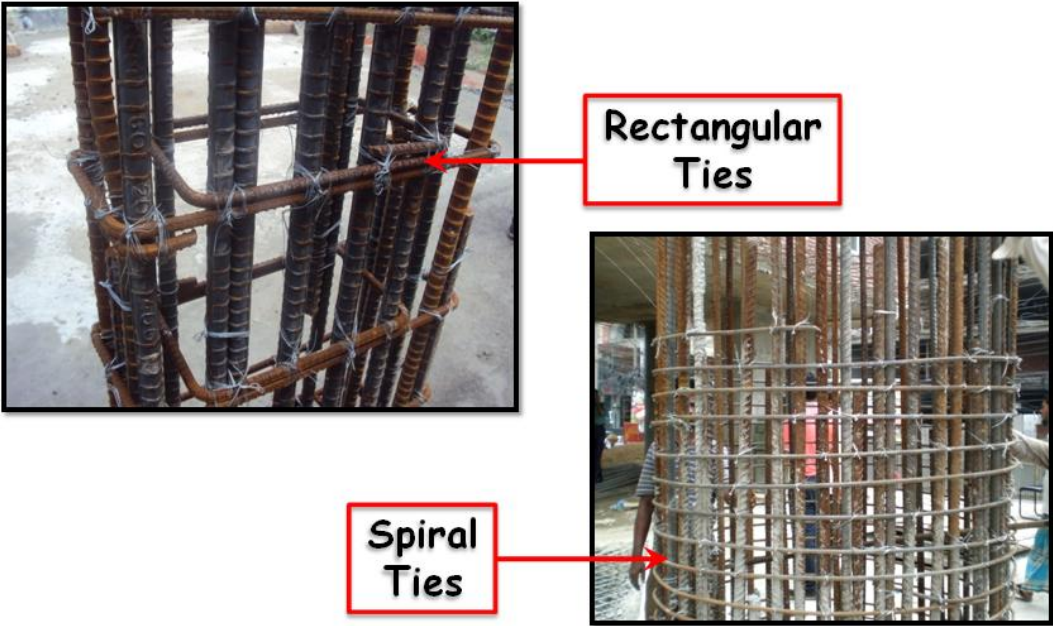
### Ties

- To prevent bursting out effect
- To maintain the vertical rods in position
- To take shear



**Fig. 3.3** Ties of column

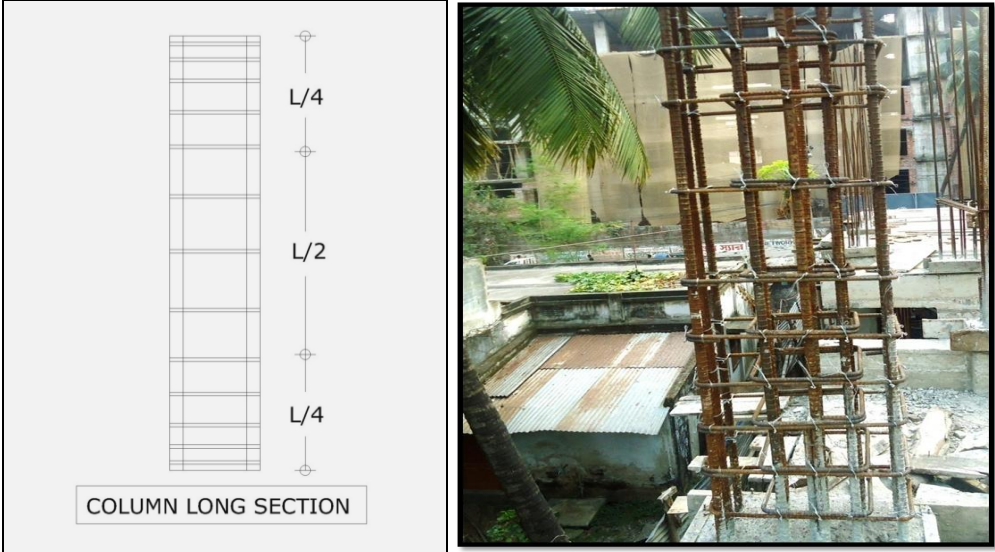
**Types of Ties**



**Fig. 3.4** Types of ties

**Placement of tie bars**

- Close ties are used near support
- Close ties are also used where rods are overlapped



**Fig. 3.5** Spacing of ties

**Hooks**



**Fig. 3.6 Hooks**

**Formwork or shuttering**



**Fig. 3.7 Steel shuttering**

### 3.1.3 Concrete casting

- Casting of concrete
- Using vibrator for compaction



**Fig. 3.8** Concrete Casting



**Fig. 3.9** Use of vibrator

### Concrete casting in multiple lifts

Concrete casting for column is often done in multiple lifts to avoid:

- Difficulties of compaction
- Segregation
- Heat entrapment during hydration



**Fig. 3.10** Concrete Casting in two lifts



### **Binding of old and new concrete by groove**

- A piece of wood or brick is used as groove
- It is used to bind new and old material



**Fig. 3.11** Groove

### **Removal of formwork and curing**

- Formwork is removed approximately after 3 days
- Curing is continued for 28 days and gunny bag is used for curing



**Fig. 3.12** Removal of shuttering

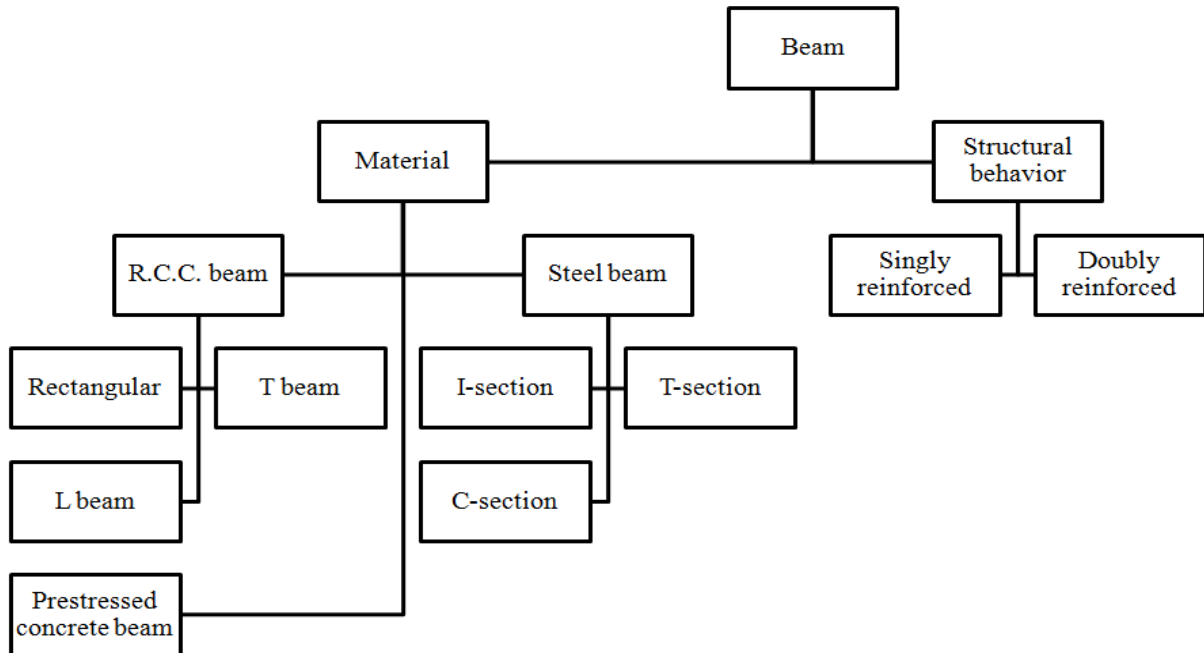


**Fig. 3.13** Curing by gunny bag

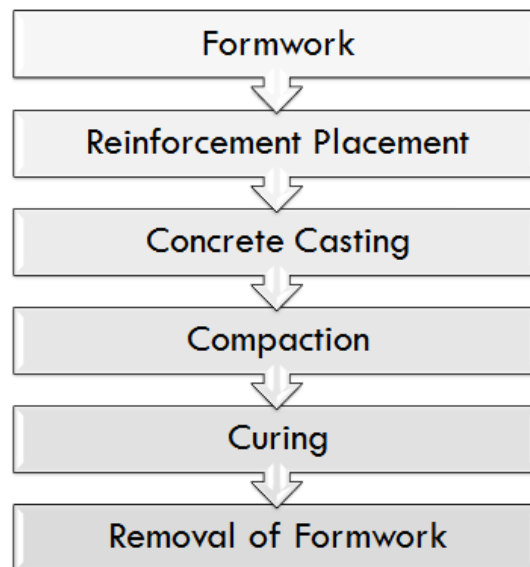
### 3.2 Beam

- Beams are those structural members which predominantly take moment and shear.
- Beam also need to take axial forces (compression and tension)

#### 3.2.1 Classification of beam



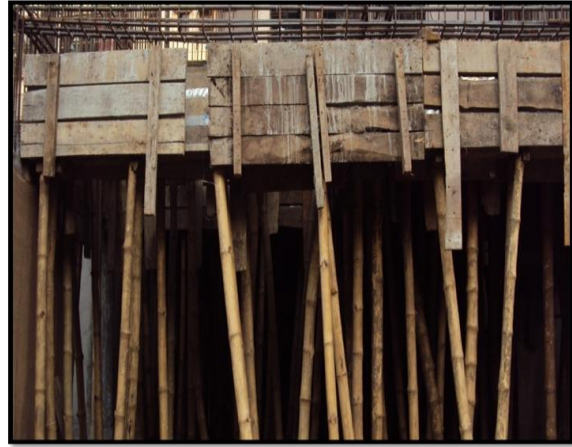
#### 3.2.2 Construction steps of beam



## Formwork of beam



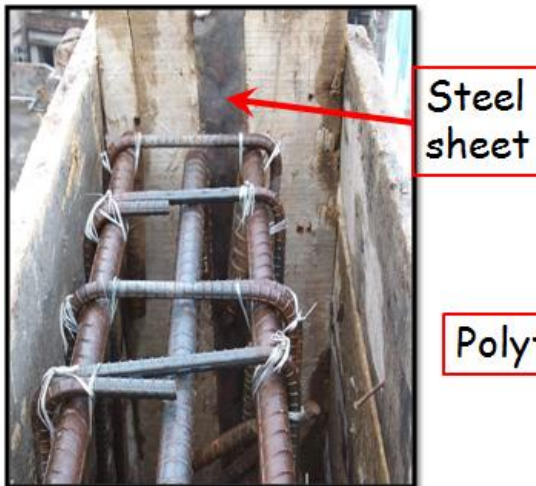
**Fig. 3.14** Steel formwork



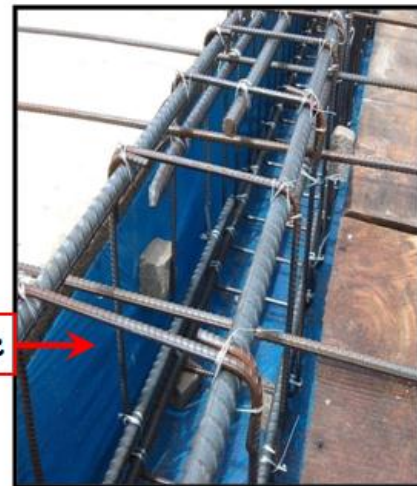
**Fig. 3.15** Timber formwork

## Measures for retaining water

- Steel sheet is used to make leak proof
- Polythene is also used

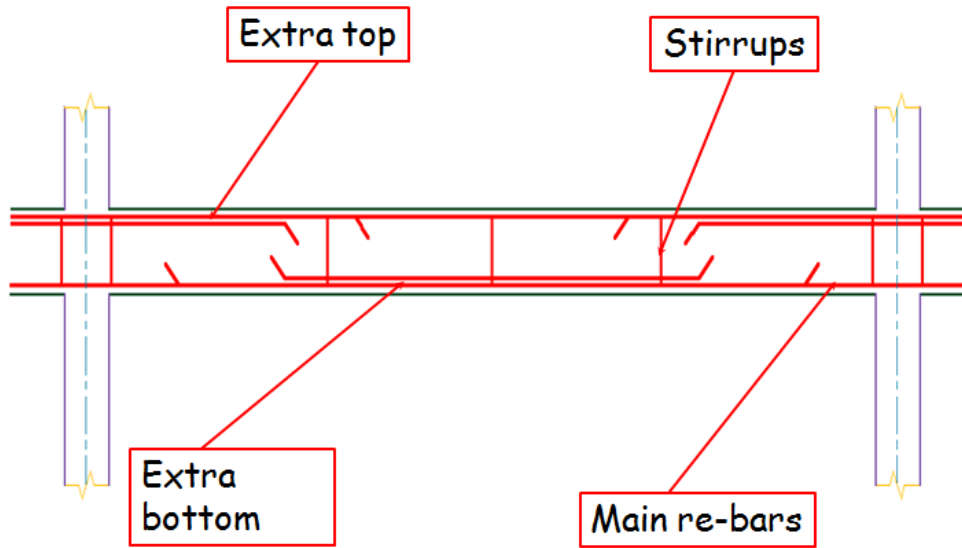


**Fig. 3.16** Steel sheet



**Fig. 3.17** Polythene

## Reinforcement of beam



**Fig. 3.18** Reinforcement of beam

## Stirrups

- Stirrups in beam function like ties in column
- Main purpose is to ensure horizontal alignment and to resist shear



**Fig. 3.19** Stirrups

## Hooks

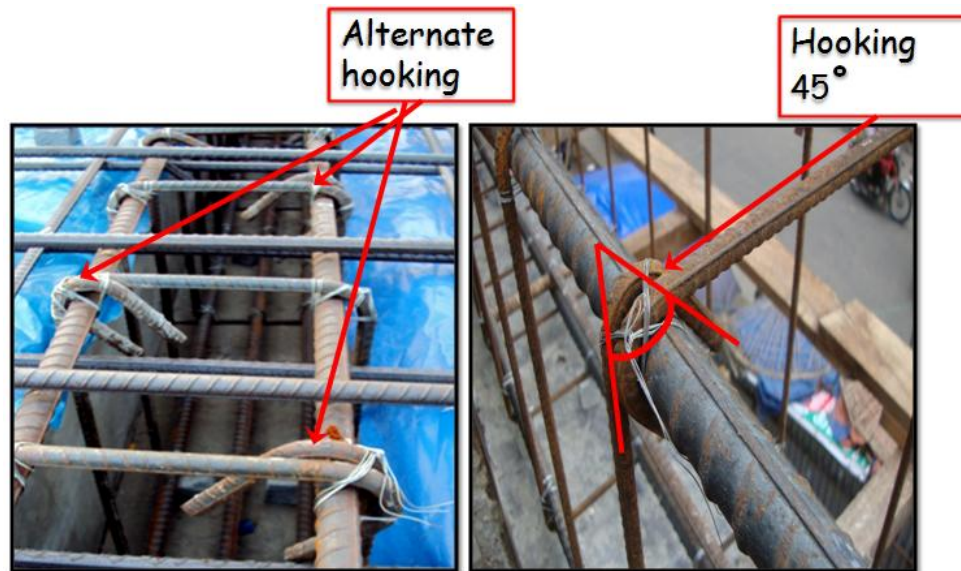


Fig. 3.20 Hooks

## Spacing of stirrups

- Close stirrups are used near joints

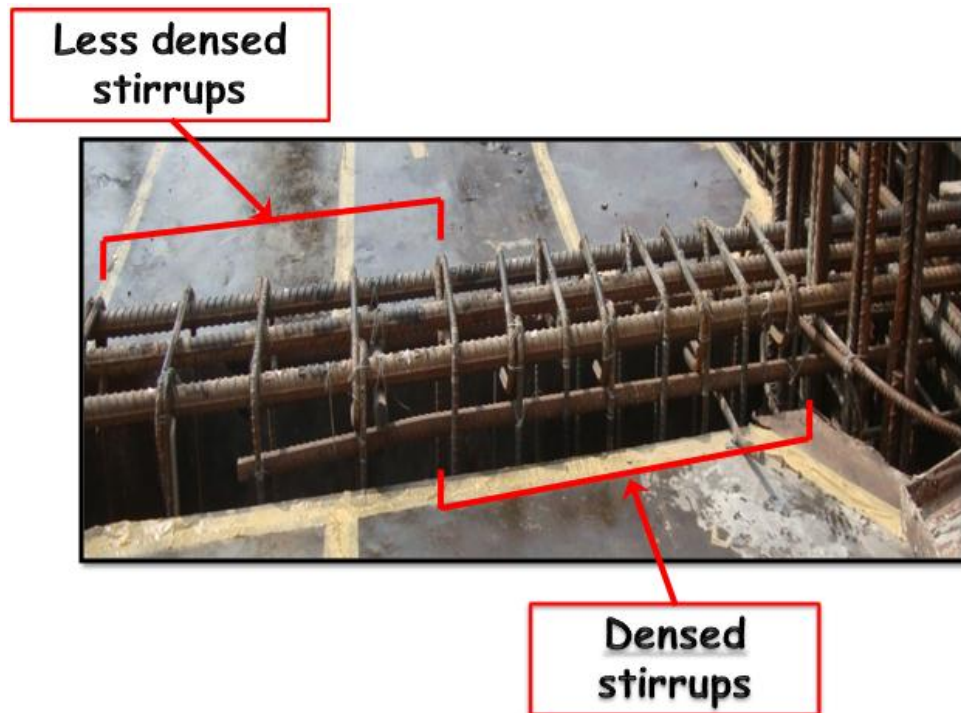


Fig. 3.21 Spacing of stirrups

### Clear cover

- C.C blocks are used to maintain clear cover



**Fig. 3.22** C.C blocks

### Casting and curing

- Generally casting of beam is done along with slab
- Sometimes at first, the lower part of beam is casted, and then the upper part is casted along with slab
- Curing of beam is done along with that of slab



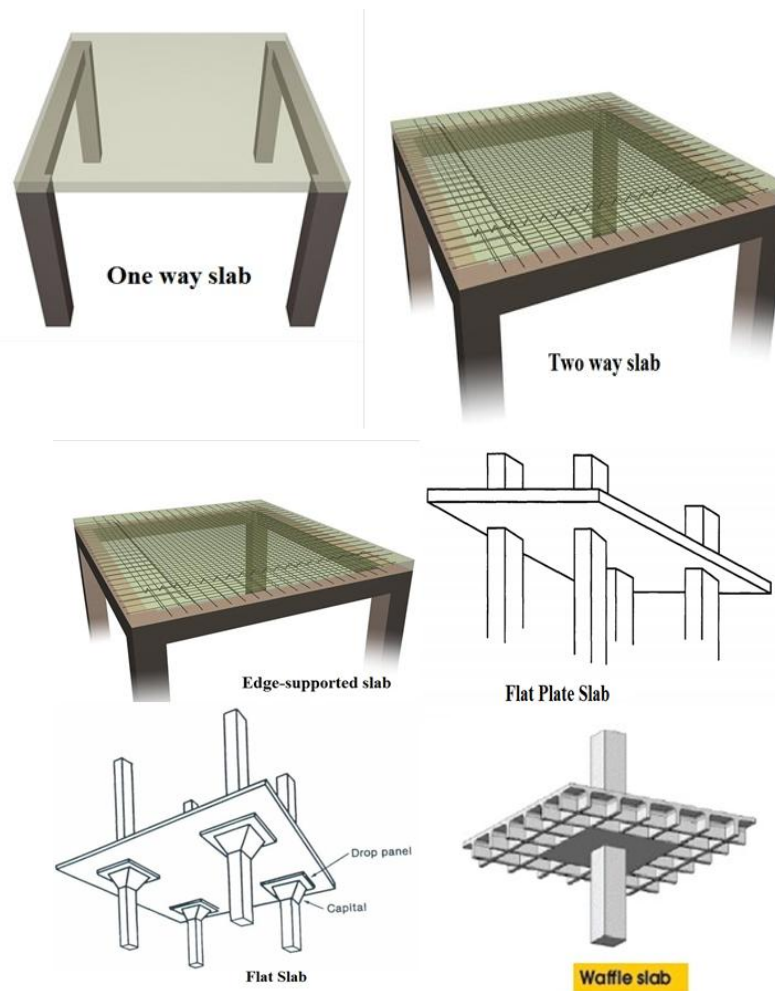
**Fig. 3.23** Monolithic casting of beam and slab

### 3.3 Slab

- A RCC (Reinforced Cement Concrete) slab is a broad, flat plate, usually horizontal, with top and bottom surfaces parallel or nearly so. It may be supported by RC beams, masonry or RC walls, structural steel members, directly by steel members or continuously by ground.

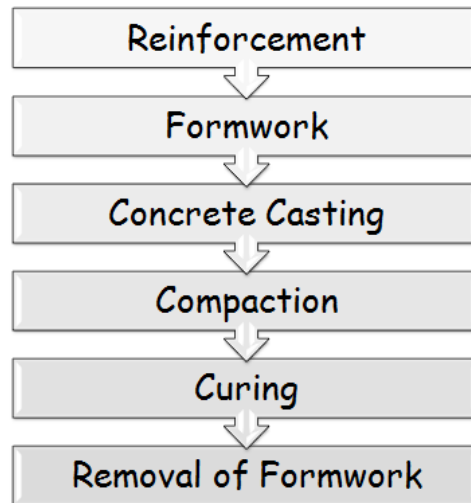
#### 3.3.1 Classification of slab

- Can be broadly classified into two categories:
  - One way slab
  - Two way slab
- Other categories:
  - Edge supported slab/ slab on beam
  - Flat slab
  - Flat plate slab
  - Waffle slab



**Fig. 3.24** Types of slab

### 3.3.2 Construction steps of slab



#### Formwork

Types of formwork

- Steel formwork
- Timber formwork

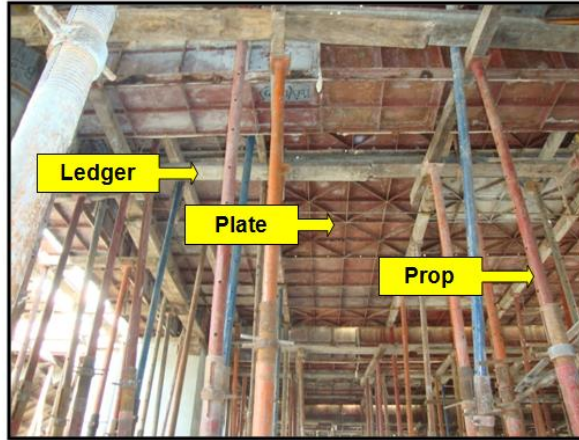


**Fig. 3.25** Steel formwork

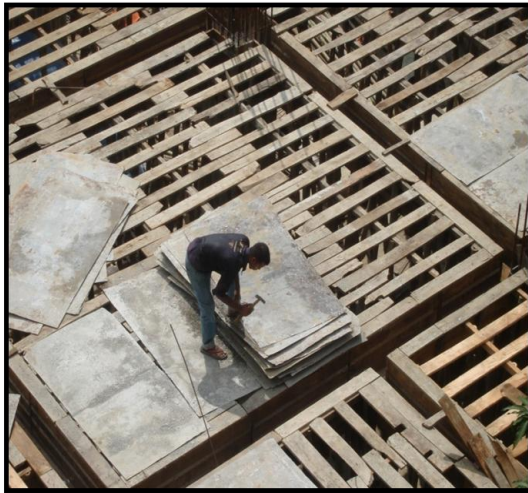


**Fig. 3.26** Timber formwork





**Fig. 3.27** Formwork/ shuttering



**Fig. 3.28** Placement of steel

**Maintaining clear cover**



**Fig. 3.29** C.C. block

## Concrete casting



**Fig. 3.30** Concrete casting

## Compaction



**Fig. 3.31** Compaction

## Leveling



**Fig. 3.32** Leveling

**Slab curing by ponding method**



**Fig. 3.33** Ponding

## 4. Brick Masonry

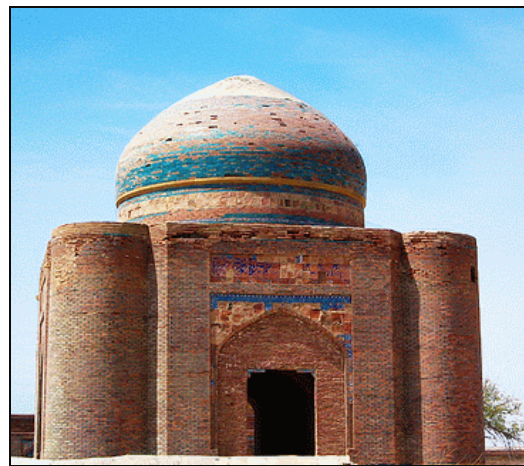
### 4.1 General features

- Brick is a compressive member
- Made from clay
- Brick structures are generally known as masonry structures where individual bricks are bonded with mortar.

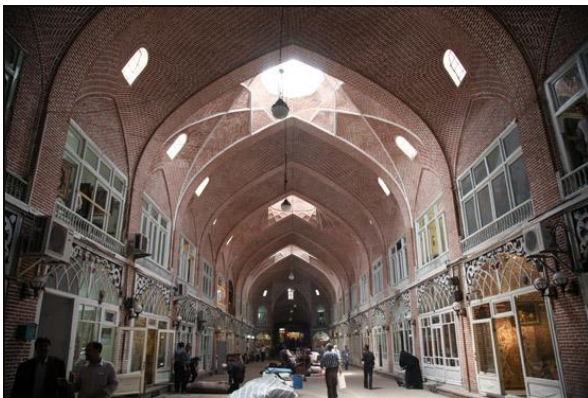
### Some brick masonry structures



**Fig. 4.1** Duplex home



**Fig. 4.2** Dome



**Fig. 4.3** Arches



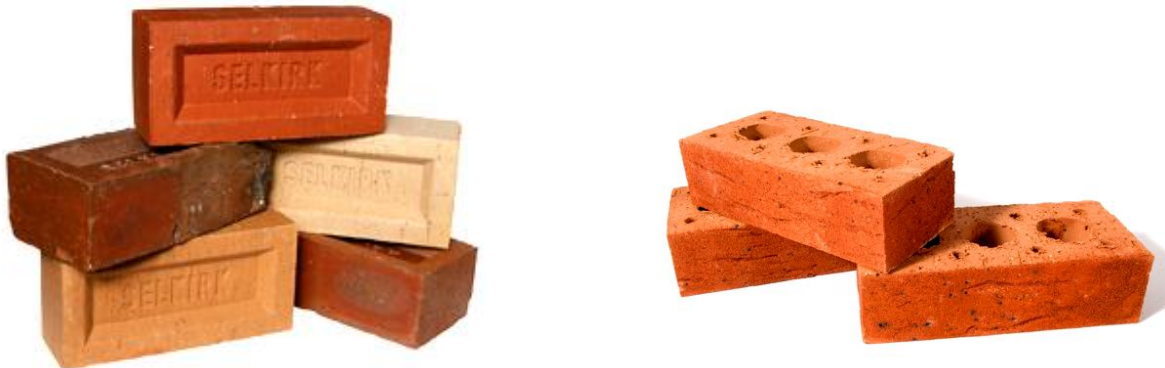
**Fig. 4.4** Arch Bridges



**Fig. 4.5** Pavement

## 4.2 Types of brick

- Pressed: Have a deep frog in one bedding surface and a shallow frog in other one
- Wire cut: 3 or 4 holes through them constituting upto 25% of the total volume of the brick



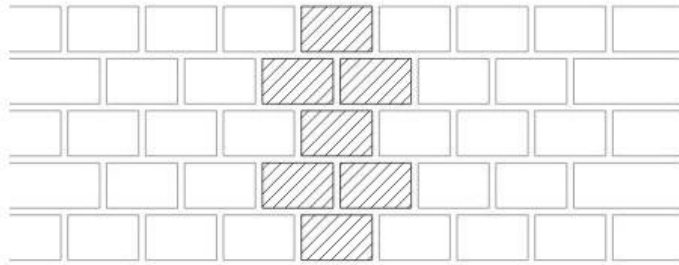
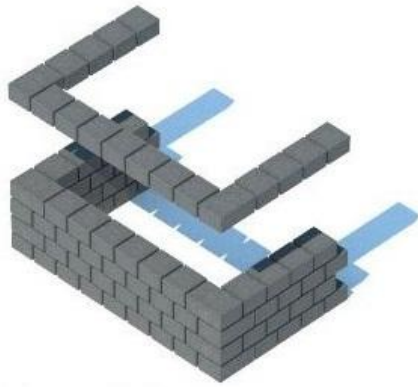
**Fig. 4.6** Different types of brick

### Brick dimensions

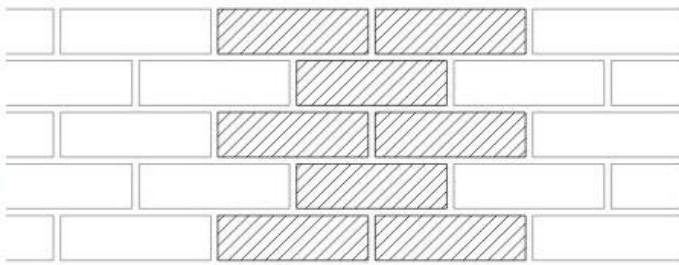
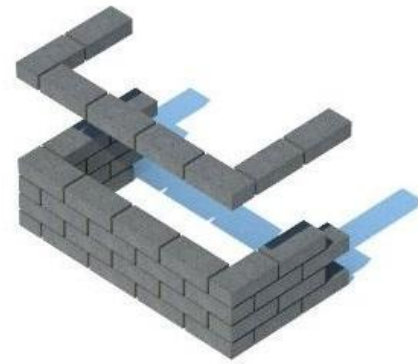
- General Dimension: 10"x5"x3"
- Nominal size: 9.5"x4.5"x2.75"
- Nominal size is a fictitious dimension which is considered in evaluating the quality of brick work
- It represents neither the actual dimension (without plaster/mortar work) nor the overall thickness (with plaster/mortar work)

### 4.3 Types of bonds in brick works

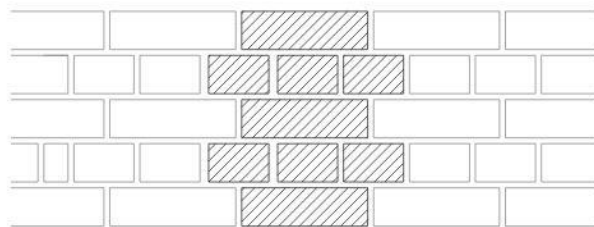
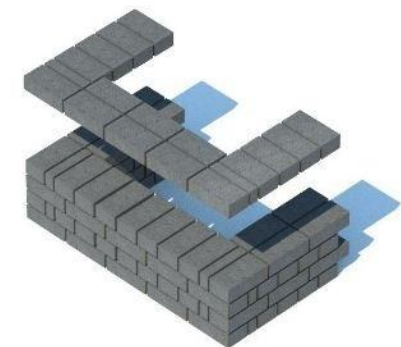
- English bond: Alternate courses of header and stretcher
- Flemish bond: Each course contains alternate header and stretcher
- Heading bond: All the bricks are laid as headers
- Stretching bond: All the bricks are laid as stretcher



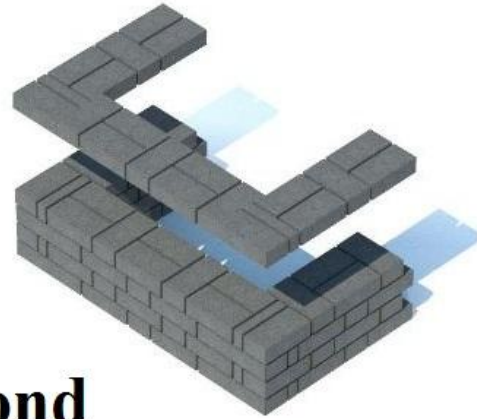
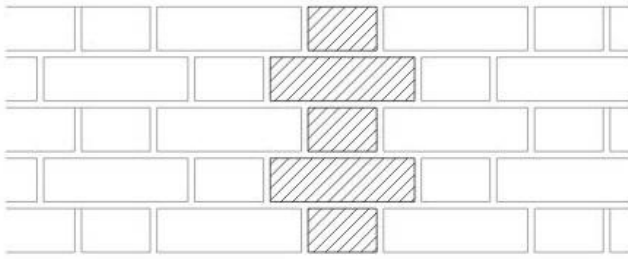
**Header Bond**



**Stretcher Bond**



**English Bond**



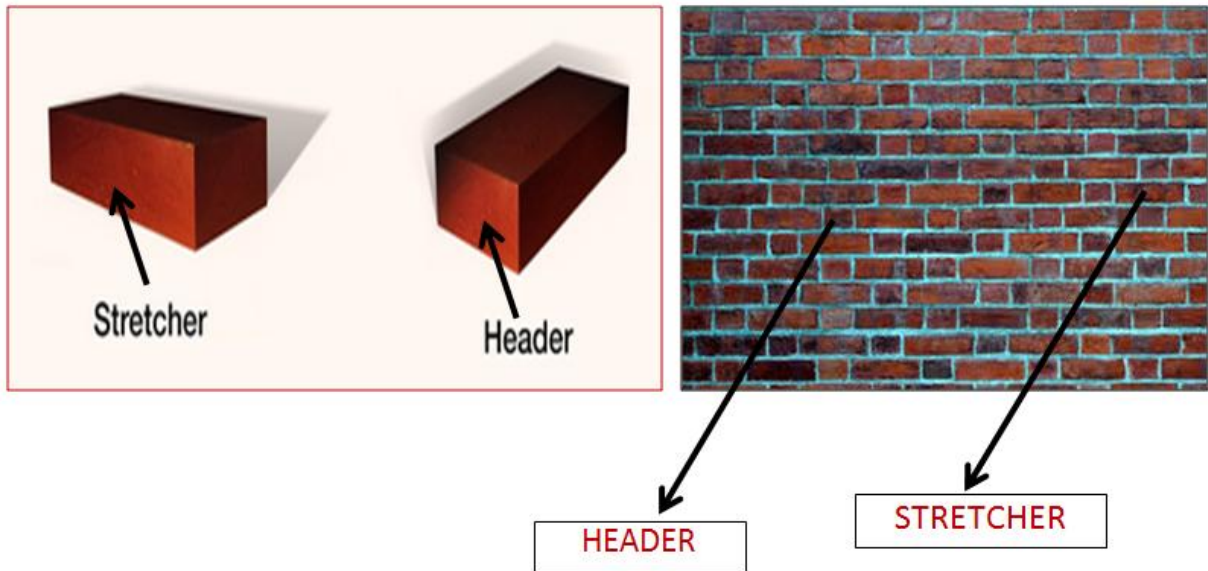
## **Flemish Bond**

### **4.4 General Principles to be observed in brick masonry construction**

- Use good quality bricks (uniform color, well burnt, exact shape and size)
- Before using brick, it should be soaked in water for 2 hours, so that bricks do not absorb water from mortar
- Bricks should be laid with frog pointing upward
- Construction of brick wall should start from joint or corner
- Courses should be perfectly horizontal
- Verticality of wall should be ensured by frequently checking using plumb-bob
- If work is stopped at a place, but is intended to be continued the next day, that place should be left with a toothed end
- Holdfasts for doors and windows should be embedded in brick masonry with cement mortar or concrete at time of constructing the wall itself
- Wall should be regularly cured for 2 weeks

### **4.5 Defects in brick masonry**

- Sulphate attack
- Crystallization of salts from bricks
- Corrosion of embedded iron or steel
- Shrinkage on dryings



**Fig. 4.7** Header and stretcher

#### **4.6 Structural limitation of brick masonry**

One problem with masonry walls is that they rely mainly on their weight to keep them in place; each block or brick is only loosely connected to the next via a thin layer of mortar. This is why they do not perform well in earthquakes, when entire buildings are shaken horizontally. Many collapses during earthquakes occur in buildings that have load-bearing masonry walls. Besides, heavier buildings having masonry suffer more damage.

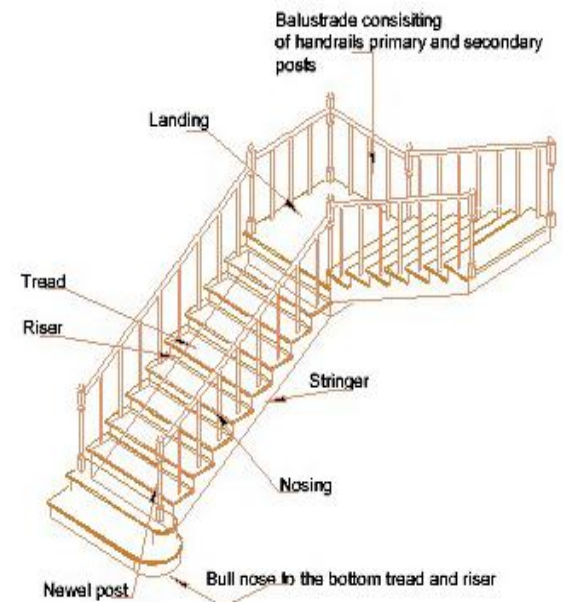
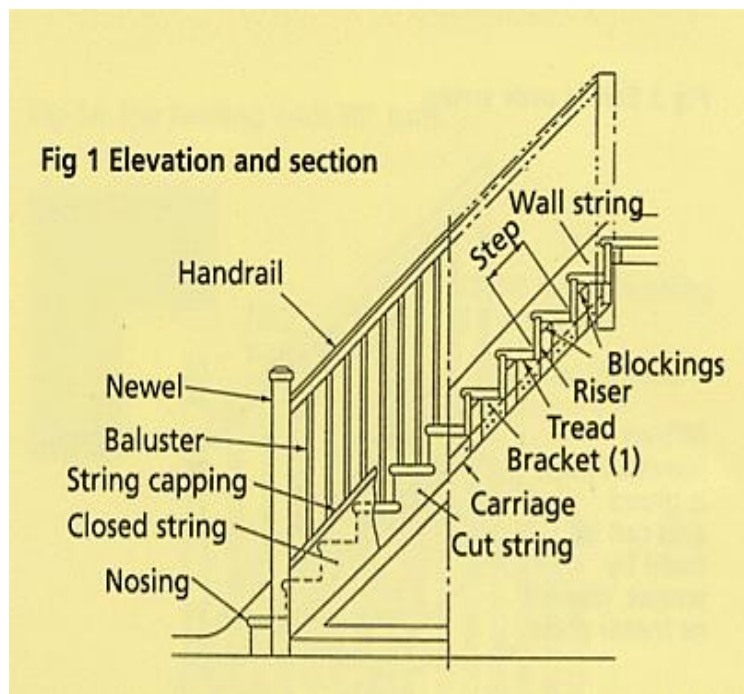


## 5. Stair

A stair may be defined as series of steps suitably arranged for the purpose of connecting different floors of a building. It may also be defined as an arrangement of treads, risers, stringers, newel posts, hand rails and baluster, so designed and constructed as to provide an easy and quick access to the different floors, rendering comfort and safety to the users. The enclosure containing the complete stairway is termed as staircase.

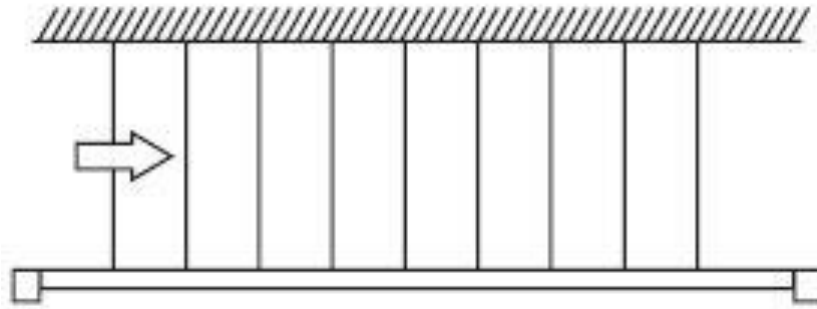
Stairs may be made from various materials like timber, stones, bricks, steel, plain concrete or reinforced concrete. The selection of the type of material to be used to depend upon the aesthetical importance, funds available, durability desired and fire resisting qualities expected.

### 5.1 Technical Terms



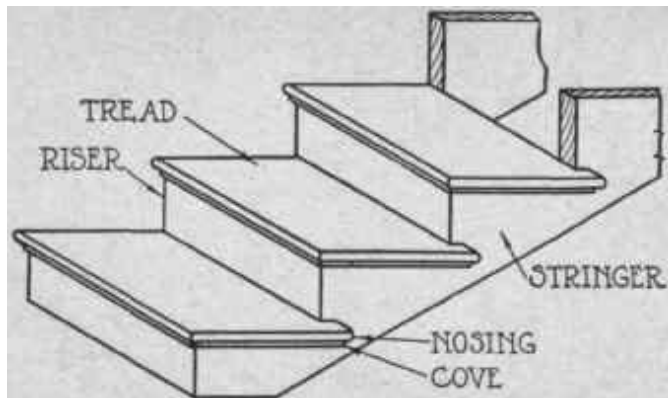
**Fig. 5.1** A Typical Stair

- 1. Steps:** A portion of a stairway comprising tread and riser which permits ascent or descent from one floor to another.



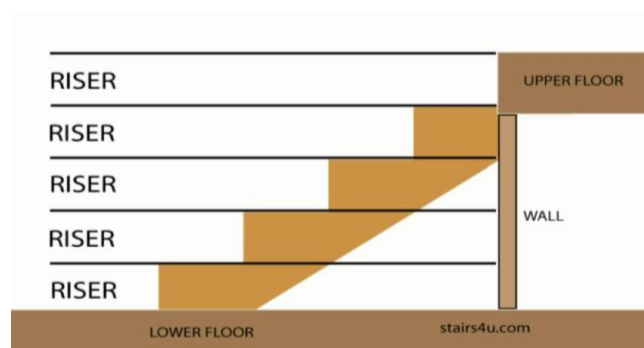
**Fig. 5.2** Steps

- Tread:** The horizontal upper part of a step of a step on which foot is placed in ascending or descending stairway.



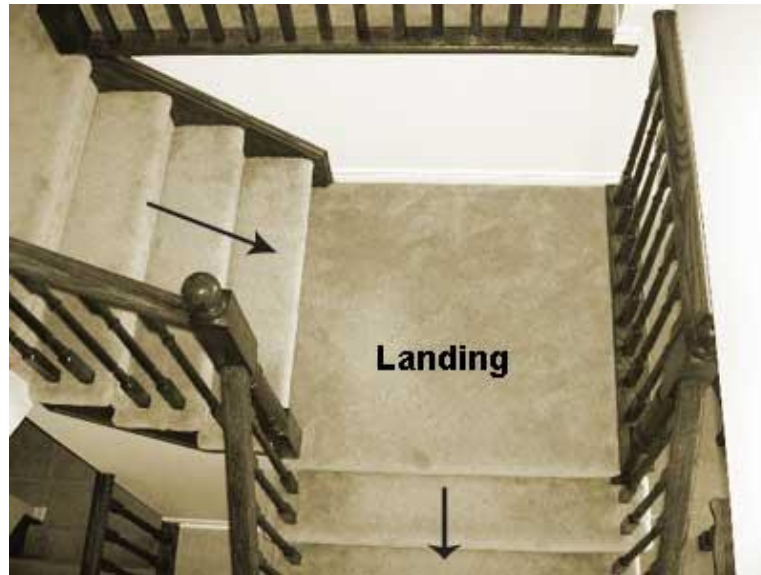
**Fig. 5.3** Tread

- Riser:** The vertical portion of a step providing support to the tread.



**Fig. 5.4** Riser

4. **Flight:** A series of steps without any platform, break or landing in their direction.
5. **Landing:** A platform or resting place provided between two flights. A landing extending right across a stair case is termed as half space landing and the one extending only half across a stair case is called a quarter space landing.



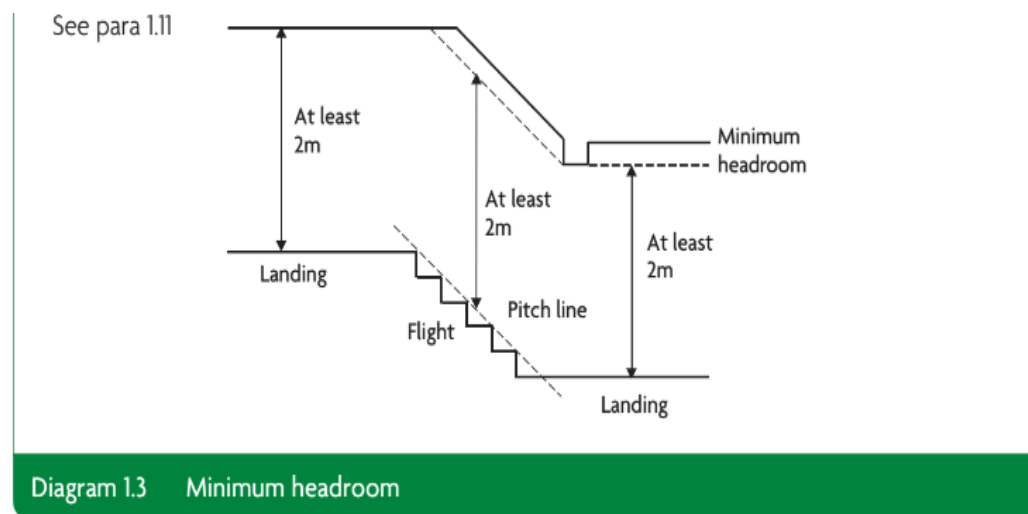
**Fig. 5.5** Landing

6. **Nosing:** The outer projecting edge of a tread is termed as nosing. Nosing is usually rounded to give good architectural effect to the treads and makes the stair case easy to negotiate.
7. **Pitch or Slope:** It is the angle which the line of nosing of the stair makes with the horizontal.
8. **Hand Rail:** It is provided to render assistance in negotiating a stair way. It is supported on balustrades and usually run parallel to the slope of the stair.
9. **Head Room or Head Way:** It is the clear vertical distance between the tread of a step and the soffit of the flight or the ceiling of a landing immediately over it.

## 5.2 Requirements of a Good Stair

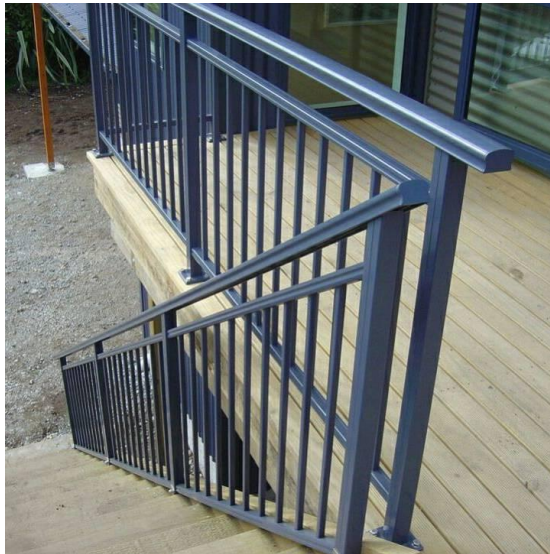
The general requirement of a good stair may be divided into the different heads, described below:

- (i) **Location:** It should be so located that sufficient light and ventilation is ensured in the stairway. If possible it should be located centrally so as to be easily accessible from the different comers of the building.
- (ii) **Width of stair:** Width of a stair varies with the situation and the purpose for which it is provided. The usually adopted average value of the stair width for public and residential building is 18m and 90cm respectively.
- (iii) **Length of flight:** For the comfortable ascent of stair-way the number of steps in a flight should be restricted to a maximum of 12 and minimum of 3.
- (iv) **Pitch of stair:** The pitch of long stair should be made flatter by introducing landings to make the ascent less tiresome and less dangerous. In general, the slope of stair should never exceed  $40^\circ$  and should not be flatter than  $25^\circ$ .
- (v) **Materials:** The stair should preferably be constructed of materials which possess fire resisting qualities.
- (vi) **Head room:** The head room or the clear distance between the tread and soffit of the flight immediately above it should not be less than 2.14m.



**Fig. 5.6** Preferable Headroom

- (vii) **Winders:** The introduction of winders in stair should be avoided as far as possible. They are liable to be dangerous and involve extra expense in construction.
- (viii) **Balustrade:** The open well stairs should be provided with balustrade so as to minimize the danger of accidents.



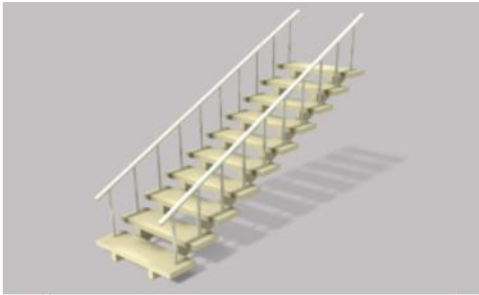
**Fig. 5.7** Balustrade

- (ix) **Landing:** The width of landing should not be less than the width of stair.
- (x) **Step proportions:** The rise and tread of each step in a stair should be of uniform dimensions throughout. The ratio of the “going” and the “rise” of a step should be proportioned as to ensure a comfortable access to the stairway.

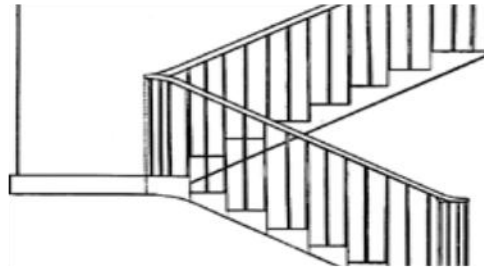
### 5.3 Classification of Stair

The different forms of stairs may be classified under the following main heads:

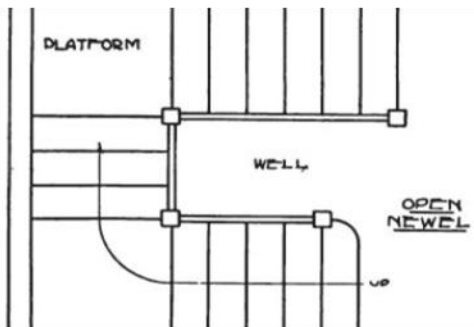
- (i) Straight stairs
- (ii) Dog-legged stairs
- (iii) Open-newel stairs
- (iv) Geometrical stairs
- (v) Circular stairs
- (vi) Bifurcated stairs



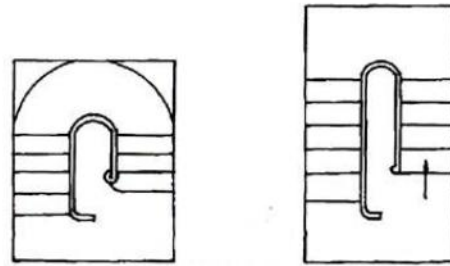
**Fig** Straight stairs



**Fig.** Dog-legged stairs



**Fig.** Open-newel stairs

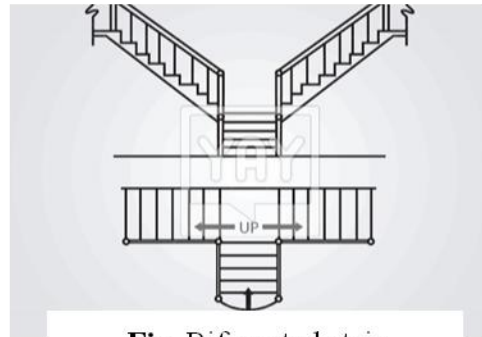


a. With landing  
b. Continuous  
**Fig. 6.7** Geometrical half turn stair

**Fig.** Geometrical stairs



**Fig.** Circular stairs



**Fig.** Bifurcated stair

**Fig. 5.8** Different Types of Stair

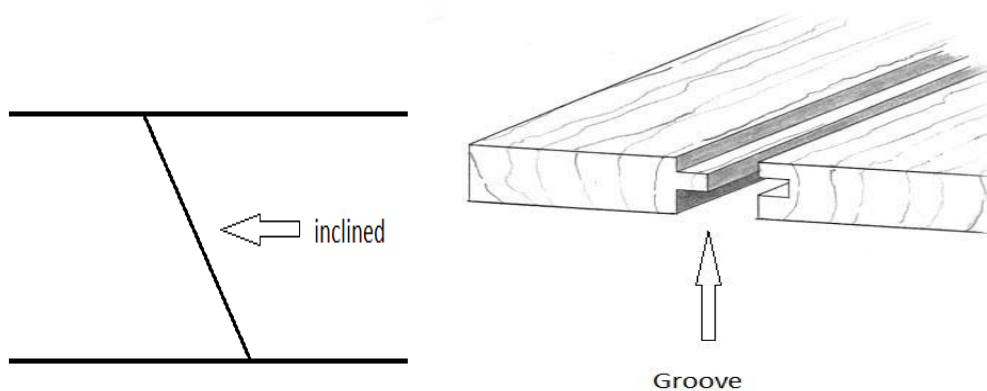
## **6. Types of Joint**

There are different types of joint that are provided during construction.

- Construction joint
- Contraction joint
- Expansion joint

### **6.1 Construction Joint**

- It is used to facilitate concrete construction for the following day; where construction is stopped either after days' work or due to other reason.
- A groove is cut at the end of days' work and a wooden block is placed. The next day, the block is removed and work is continued using fresh concrete.
- The target is to ensure proper bonding between old and new work and to prevent the formation of any weak surface (which is vulnerable to shear failure).
- Construction joint should be placed at such a point where shear force is either zero or minimum, i.e. placed far away from support.



**Fig. 6.1** Construction Joint

## 6.2 Expansion Joint

- It is used to facilitate expansion of concrete. Concrete expands due to increase in temperature.
- Bigger structure needs larger expansion gap.
- Failure to provide sufficient expansion gap may lead to crushing in concrete and weaken the structural capacity.
- Joint filler: compressible material made of bitumen, cork, rubber, plastic etc.
- Water bar: to seal against passage of water, made of rubber/ PVC/ metal



**Fig. 6.2** Expansion Joint

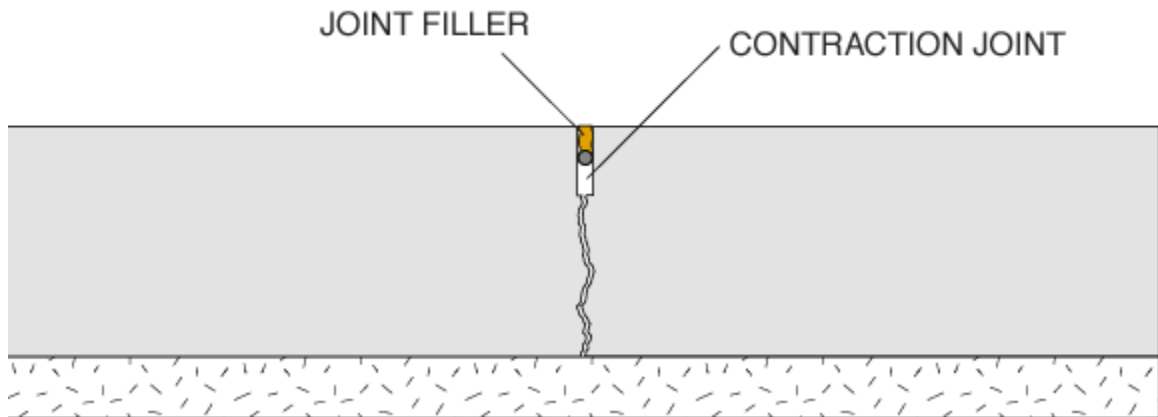
### 6.2.1 Importance of Expansion joint

- Building materials expands or contracts due to change in temperature and variation in moisture content.
- Results in formation of cracks.
- Remedy: break continuity of structural members/ portions, introduce joints, subdivide the building members into smaller units and permit free movement.



### 6.3 Contraction Joint

- When concrete sets and hardens in air, it shrinks in volume, resulting in development of tensile stress.
- If it exceeds the tensile capacity of concrete, cracks can form
- We want to control the location where cracks form.



**Fig. 6.3** Contraction Joint

## **7. Shoring, Underpinning and Scaffolding**

### **7.1 Shoring**

The term “shoring” is applied to construction of the temporary structure required to support an unsafe structure.

**The main objects of shoring may be summarized as below:**

- When the walls of a building develop signs of bulging or leaning outwards, shoring is necessary to prevent further development of the defect.
- When defective walls of a building are to be dismantled and rebuilt, shoring is resorted to for supporting the floors or roofs connecting to the walls.
- Shoring is necessary to support the super structure when large openings are required to be made in the main walls of two adjacent buildings when the intermediate building is to be pulled down and rebuilt.



**Fig. 7.1** Structural Shoring

## 7.2 Underpinning

This term is applied to the building of New York underneath an existing structure without disturbing its stability. Underpinning may be necessary when defective foundation of a wall is to be replaced with new foundation or when the existing foundation of a wall is required to be strengthened to enable it to carry more loads.



**Fig. 7.2** Underpinning

### 7.3 Scaffolding

Scaffold is a temporary rigid structure having platforms raised up as the building increases in height. Scaffold enables the mason to work at different stages of a building and to hoist the materials for the immediate use at various height.



**Fig. 7.3** Scaffolding

## **8. Details of Roof**

The structure forming the upper covering of a building is known as roof. There are some common components of roof which are usually provided such as:

- Parapet
- Rainwater spouts
- Stair case
- Roof covering
- Overhead water Tank

There are some other components that may also be seen on a roof.

- Plumbing lines
- Lift machine room
- Telecom Tower
- Garden
- Community Centre

### **8.1 Parapet**

- To ensure safety
- Increase of height will cause increased load coming from wind
- In case of brick parapet, placement of brick should occur before the slab concrete is hardened to ensure proper bonding
- If brick is placed after slab concrete has hardened, chipping must be applied first.
- If future extension of building is required, brick parapet is favorable.



**Fig. 8.1** Parapet

## 8.2 Rain Water Spouts

- To ensure fast removal of rain water from rooftop
- The number of spouts and their positions, placement should be accurate.
- Must have adequate diameter to avoid clogging.
- Poor reinforcement of rain spout may lead to structural failure.



**Fig. 8.2** Rain Water Spout

## 8.3 Stair Case

- Stair case is the room which covers the stair landing towards roof
- It protects the inner opening of the building through stairs from entering rain water and direct sun light.
- It can also contain overhead water tank over it.

## 8.4 Roof Covering

- To protect dampness.
- To ensure movement of rain water towards the spout.
- Damp proof materials: lime concrete, bitumen etc.



**Fig. 8.3** Typical Slope of Roof Cover



**Fig. 8.4** Roof Cover

### **8.5 Plumbing Lines**

- These are water pipes which supplies water from overhead tank to the all floor
- These also uplift water through them from reservoir to overhead tank.



**Fig. 8.5** Plumbing Lines

### **8.6 Lift machine room**

- It's a room where lift machine is placed.
- It situated on the room just beside stair case
- Lift control machine is placed here with proper coupling and electric arrangement.

### **8.7 Overhead Water Tank**

- It's a water container which usually placed on the roof of a building.
- It's usually placed over stair case so that the water pressure is sufficient for the top floor people.
- It can be constructed by RCC or it can be ready made tank like GAZI tank, RFL tank etc.

### 8.7.1 Overhead water tank design calculation

Let,

6 storied apartment

5 floors- 3 units

total number =  $6 \times 3 \times 5 = 90$

According to BNBC, for residential use of water,

use of water=40 gpcd

So total water consumed =  $90 \times 40 = 3600$  gpd

= 36000 lb per day; [1 gallon water= 10 lb]

=  $36000/62.4 = 580$  cft/day

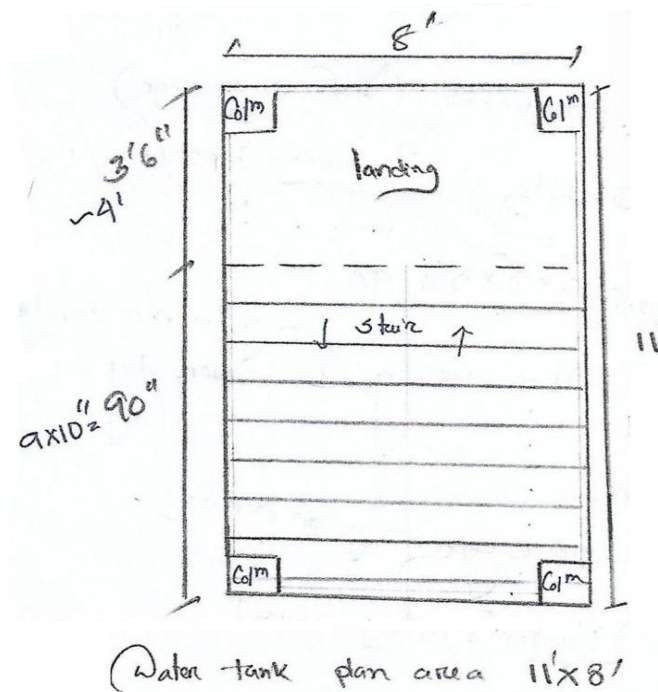
For pumping water twice a day,

Volume of water in water tank =  $580/2 = 290$  cft

Area =  $11' \times 8' = 88'$

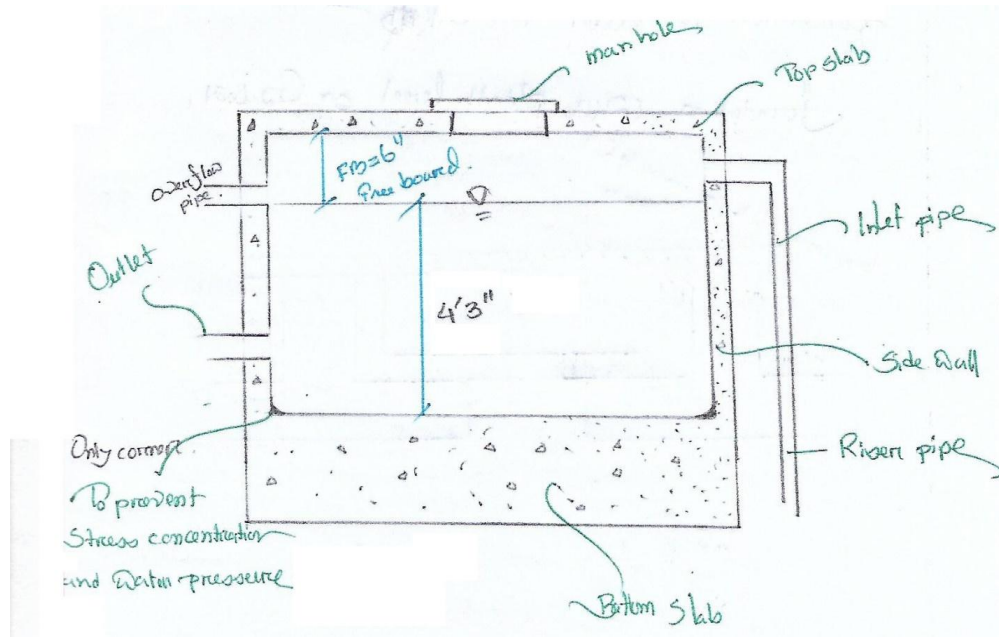
Depth =  $290 / \{ (8'-1') \cdot (11'-1') \} = 4.25$  ft = 4ft 3in

So total tank height = Bottom slab+ 4'3''(water height) + 6'' (Free board ) + top slab



**Fig. 8.6** Plan View of Inside Stair Case





**Fig. 8.7** Elevation View of Overhead Water Tank

## 8.8 Underground Water Tank

- In an underground water tank there should be minimum reserved water for 2 days.
- The height of an underground water tank should be foundation level to plinth level or less than plinth level.

### 8.8.1 Underground Water Tank Design Calculation

Total amount of water required 580 cft/day.

Assuming that, two days water would be stored in the UGWR.

Volume of water to be stored in UGWR =  $580 \times 2 = 1160$  cft

Here,

Depth of footing,  $D_f = 9'$

Free Board, F.B = 6"

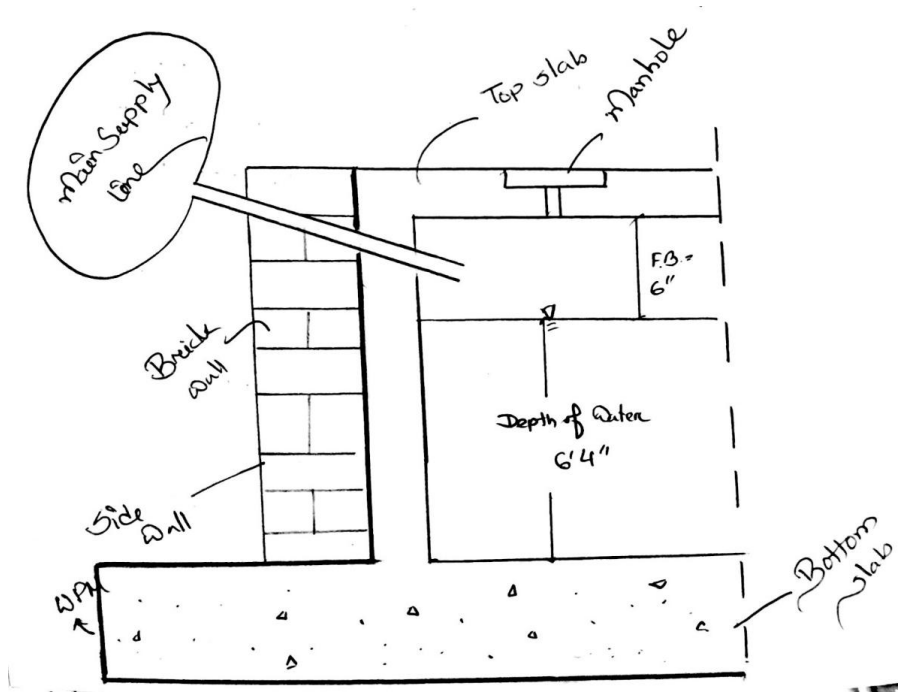
Thickness of footing = 18"

Bottom Slab = 8"

Depth of water in UGWR =  $D_f - \text{Thickness of footing} - \text{Thickness of bottom slab} - \text{Free board}$

So, Depth of water =  $9' - 18'' - 8'' - 6'' = 6'4''$

Water tank surface area =  $(1160/6.33)$  sqft  
= 183.25 sqft



**Fig. 8.8** Cross-Section of Underground Water Tank

## **9. Construction Materials**

The main materials which are used in building constructions are:

- Concrete
- Cement
- Aggregate (Fine, Coarse)

### **9.1 Concrete**

Concrete is a composite material composed of coarse aggregate bonded together with a fluid cement that hardens over time. Most concretes used are lime-based concretes such as Portland cement concrete or concretes made with other hydraulic cements, such as However, asphalt concrete, which is frequently used for road surfaces, is also a type of concrete, where the cement material is bitumen, and polymer concretes are sometimes used where the cementing material is a polymer.



**Fig. 9.1** Aggregates in Concrete

## 9.2 Cement

A powdery substance made by lime and clay, mixed with water to form mortar or mixed with sand, gravel, and water to make concrete. Cement sold in a bag 50 kg weight per bag (1.25 cft).



**Fig. 9.2** Cement

## 9.3 Aggregate

There are two types of aggregate such as: (i) Fine Aggregate, (ii) Coarse Aggregate.

### 9.3.1 Fine Aggregate

Fine aggregate are basically sands won from the land or the marine environment. Fine aggregates generally consist of natural sand or crushed stone with most particles passing through a 8mm sieve. As with coarse aggregates these can be from Primary, Secondary or Recycled sources.

- Fine sand (FM > 0. ) e.g. – Mymensigh Sand
- Coarse sand (FM>2.5) e.g. – Sylhet Sand
- Sold in terms of truck



**Fig. 9.3** Fine Aggregate

### 9.3.2 Coarse Aggregate

Maximum size of course aggregate is (3/4 inch, i.e. it is  $\frac{3}{4}$  inch downgrade) larger size reduces surface area. Most Commonly used course aggregates are:

#### **Brick Chips:**

- Jhamma brick chips are used, sold in terms of trucks ( 1 truck = 2000 cft) .
- Brick chips are used in slab casting.

#### **Stone Chips:**

- Sold in terms of trucks.
- Stone chips are used in foundation, column, and beam.
- Surface roughness of stone chips helps is aggregate.

#### **Shingles:**

- Sold in terms of truck.
- Roundness of shingles helps in workability of concrete.



**Fig. 9.4** Coarse Aggregate

## 9.4 Brick

According to the quality bricks are classified in different classes:

1. 1st class (S class)
2. 2nd class (A class)
3. 3rd class (B class)
4. Jhama bricks (over burnt)
5. Pilla Bricks (under-burnt)

Classification is based on strength, water absorption, efflorescence etc. If bricks is not burnt well, its strength will not be good. Jhama bricks are used in foundation



**Fig. 9.5** Brick

## **10. Mixing and Placing of Concrete**

### **10.1 Concreting**

- Mix ratio (volumetric ratio of the components, namely cement, fine aggregate and coarse aggregate, at the time of mixing) e.g. C : FA : CA = 1:2:4
- The ideal mixing composition is different from site to site, as its needs to take into account strength, workability, availability of materials, rate of hydration etc.



**Fig. 10.1** Concreting

### **10.2 Water-Cement Ratio**

- It is the ratio of mass of water to the mass of cement in fresh concrete. Usually, it is kept at between 0.3 to 0.5.
- Higher the water/cement ratio generally reduces the strength of concrete, but workability is increased as well.

**Math Problem:**

Find the volumes of cement, CA and FA required to produce 100 cft of dry concrete, given the mix ratio of 1 : 2 : 4

**Solution:**

Shrinkage factor = 1.5 (assumed)  
= (fresh volume / dry volume)

So, fresh volume =  $1.5 \times 100 = 150$  cft

$$X + 2X + 4X = 150$$

or,  $X = 21.43$  cft

So,

Cement =  $21.43$  cft =  $(21.43/1.25) = 17.144 \approx 18$  Bags

Fine aggregate =  $(21.43 * 2) = 42.86$  cft  $\approx 45$  cft

Coarse aggregate =  $(21.43 * 4) = 85.72$  cft  $\approx 90$  cft

(Ans)

**Factors that affect the concrete mix design strength are:**

- a) Water / Cement Ratio
- b) Cement concrete (weight of cement per unit volume of fresh concrete)
- c) Relative proportion of fine & coarse aggregate
- d) Use of admixture

**10.3 Equipment to Mix Concrete**

- 1) Mixing Machine
- 2) Ready Mix Truck



### 10.3.1 Mixing Machine

- 2 types based on volume of concrete produced
- 5 cft drum and 10 cft drum
- The smaller drum ( 5cft concrete) can produce 120 to 150 cft concrete per hour. So for a 8 hours workday ; it produces 1000 to 1200 cft
- The concrete is mixed on site



**Fig. 10.2** Mixing machine

### 10.3.2 Ready Mix Truck

- It carries concrete from ready mix plant to the filed. (the concrete carried is RMC)
- Capacity of truck varies from 200 to 220 cft
- For a 8-hours workday, a 200 cft capacity truck can caary 1600 cft concrete to site , if it takes one hour to travel from site to plant and back.

#### **Criteria to choose between mixing truck (RMC) and mixing plant (in-situ concrete)**

- Quality control
- Time limit
- Cost
- Room required
- Distance from RMC factory

RMC truck usually shortens time of construction. Although the truck option is expensive, it reduces other costs, such as labor, electricity etc.



**Fig. 10.3** Ready mix truck

# **11. Shuttering and Curing**

## **11.1 Shuttering**

Shuttering is used to maintain concrete shape and volume while it is being cured

Types of shuttering (based on material):

- Wood
- Steel
- Plastic



**Fig. 11.1** Shuttering

## 11.2 Curing

Curing of concrete is defined as the process of maintaining the moisture and temperature conditions of concrete for hydration reaction to normally so that concrete develops hardened properties over time. The main components which needs to be taken care are moisture, heat and time during curing process.

### 11.2.1 Methods of Curing

- Spraying Water
- Wet Gunny Bags
- Ponding
- Curing by infra-red radiation
- Membrane curing
- Steam Curing
- High pressure steam curing
- Low pressure steam curing



**Fig. 11.2** Curing

## **12. Building Finishes and Building Services**

Finishing works is a fine job in building construction process where it forms the beauty of a building. Several types of finishes can be used based on the materials used, environmental conditions and cost. Finishing of a building can be divided into several sections:

- Ceiling finishing
- Wall finishing
- Floor finishing

### **12.1 Plastering**

This is a process of covering rough surface with a plastic material to obtain an even, smooth, regular, clean and durable surface. Plastering is required to provide a satisfactory base for decorating the surface by white-washing, color washing, distempering and painting. External plastering is also done with the object of improving the resistance of the surface to rain water penetration and other atmospheric influences.

#### **12.1.1 Types of Plaster**

- Lime plaster
- Cement plaster
- Mud plastering
- Stucco plastering

### **12.2 Pointing**

In exposed brick or stone masonry, mortar joints are considered to be weakest spots for giving access to rain water or dampness. Pointing consist in raking out joints in brick work or in stone masonry, to depth of about 13 mm and filling the same with mortar of slightly richer mix. This treatment not only protects the joint from the adverse effect of atmosphere but also magnifies the appearance of the surface by exhibiting the pattern of the joints, their thickness, colors and texture prominently.

### **12.3 White Wash**

- Made from pure flat lime (white stone lime) or shell lime
- As a rough guide 5 liters of water should be added to each kg of lime
- Alum/common salt may be added to stick the coating well to the surface
- Usually applied to exteriors
- Used as a primary coating during paint

### **12.3.1 Application of White Wash**

- Applied in a specified number of coats until the surface presents a smooth & uniform finish
- Usually three coats for new work and one/two coats for old work
- Each coat consists one top to downward stroke and other bottom to upward
- Similarly one horizontal stroke from left to right and another right to left
- Each coat be allowed to dry before the next one is applied

### **12.3.2 Purpose of White Wash**

- For coloring (aesthetic purpose)
- Protect brickwork from moisture

## **12.4 Paints**

Paint is applied on timber, metal, brick or other materials in the form of a liquid which, on drying, forms a thin film on the painted surface. The essential function of the paint film is to provide protection or decoration or both.

### **12.4.1 Types of Paints**

The various types of paints commonly used can be broadly divided in the following categories:

- (i) Aluminium paints
- (ii) Anti corrosive paints
- (iii) Asbestos Paints
- (iv) Bituminous paints
- (v) Bronze paints
- (vi) Cellulose Paints
- (vii) Cement based paints
- (vii) Enamel paints
- (viii) Oil paints
- (ix) Rubber based paints

## **12.5 Varnish**

Varnish is a clear pale solution of a resinous substance dissolved in either oil, turpentine or alcohol. The solution on drying forms a hard, transparent, glossy film on the varnished surface. Varnish plays an important role in finishing wooden surface of doors, window, floors etc. The preparation of varnish is a tedious job and as such as far as possible readymade varnishes should be used for all jobs.

### **12.5.1 Types of Varnish**

Depending upon the solvent used, varnishes may be classified as below:

- Oil varnish
- Spar varnish
- Flat varnish
- Asphalt varnish
- Spirit varnish

### **12.6 Sound Insulation/Sound Proofing/Acoustic Insulation**

- Is a means of reducing the sound pressure with respect to a specified sound source and receptor.
- There are several basic approaches to reducing sound noise:
- By decreasing the distance between source and receiver,
- Using noise barriers to absorb the energy of the sound waves,
- Using damping structures such as sound baffles,
- Using active anti-noise sound generators.

#### **12.6.1 Commonly Used Method For Sound Insulation**

- Damping
- Absorption
- Reflection
- Diffusion

### **12.7 Thermal Insulation**

- Thermal insulation is the reduction of heat transfer between objects in thermal contact.
- Thermal insulation can be achieved with especially engineered methods, as well as with suitable object shapes and materials.
- Thermal insulation provides a region of insulation in which thermal conduction is reduced or thermal radiation is reflected rather than absorbed by the lower-temperature body.

### **12.7.1 Importance of Thermal Insulation**

When well insulated, a building:

- Is energy-efficient, thus saving the owner money.
- Provides more uniform temperatures throughout the space. Thus producing a more comfortable occupant environment when outside temperatures are extremely cold or hot.
- Has minimal recurring expense. Unlike heating and cooling equipment, insulation is permanent and does not require maintenance, upkeep, or adjustment.



## **13. House Plumbing**

### **13.1 Plumbing System**

- The entire system of piping, fixtures appliances, etc, for providing water and gas supply to a building.
- Used as a means for supply of fresh water and disposal of waste water from the building.

#### **13.1.1 Objective of Plumbing System**

- To provide sufficient amount of water to serve each fixture.
- To provide of no opportunity of backflow of used water into the water supply pipes.
- Wastes should be disposed of promptly and hygienically

#### **13.1.2 Plumbing Components**

- Pipes
- Taps, Valves and stopcocks
- Fixtures
- Water tanks

#### **13.1.3 Types of Plumbing Joint**

- Elbow joint
- U-Trap Joint
- Coupling
- Tee
- Cap



**Fig.** Elbow Joint



**Fig. U-Trap Joint**



**Fig. Coupling**



**Fig. Tee Joint**



**Fig. Cap**

## **13.2 Types of Plumbing**

- Water Supply Plumbing
- Drainage Plumbing or Drainage System

### **13.2.1 Water Supply Plumbing**

- Direct System
- Indirect System

#### **1. Direct System**

- Supply of water is given to various floors in a building directly from the main.
- Sufficient pressure is provided to feed all the floor and sanitary fitting at the highest part of the building.

#### **2. Indirect System**

Indirect water supply system comprises of two supply systems. Such as:

- Up feed
- Down feed

#### **Up Feed**

Water is supplied in sufficient pressure by machine or by providing mechanical energy.

#### **Down Feed**

- water is distributed to the floors from the overhead storage tanks
- no need of extracting extra pressure because of gravitational energy water is distributed along the floors

### **13.3 Drainage System**

The drainage system means the removal of all the water wastages in a distributed way.

#### **13.3.1 Types of Drainage System**

- Sanitary Drainage System
- Storm water Drainage System

##### **1. Sanitary Drainage System**

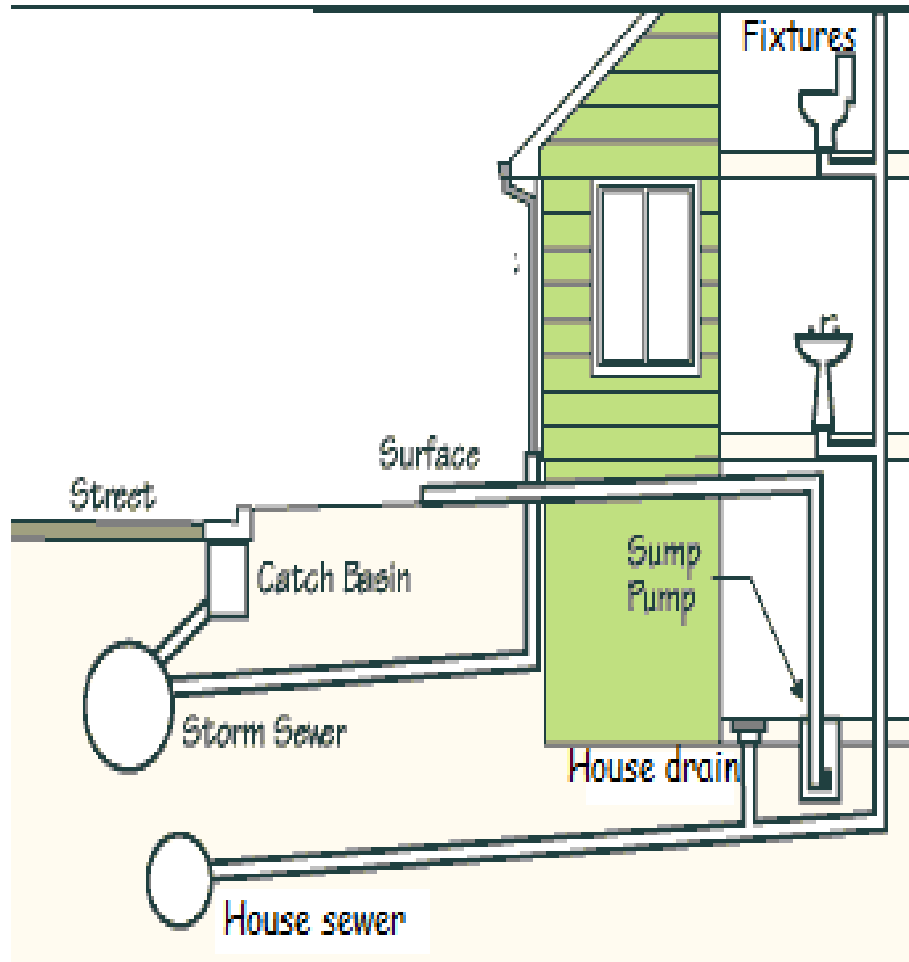
The system that drains water from sinks, tubs, showers, lavatories & soil matter from toilets is known as sanitary drainage system. Here two pipe system is commonly used.

#### **Components of Sanitary Drainage System**

- House sewer
- House drain
- Soil, waste, vent stacks
- Fixture branches & branch vents
- Fixture traps & Fixtures

##### **2. Storm water Drainage System**

The system that collects storm water from roofs, yards & areaways is known as storm water drainage system.



**Fig. 13.1** Drainage System of a Building

### 13.3.1 Drainage Pipe Requirements

- Provision of adequate supports for drainage pipes during construction of building.
- Pipe lay out should be direct and simple. Pipes should be laid in straight lines.
- Any abrupt changes in the direction of flow should be avoided. The contained angle between two intersecting pipes should not be less than  $45^\circ$ .
- The drainage pipes should be sufficiently strong and durable. They should also be air-tight and gas tight.
- The pipe-joints should be strong and leak proof.
- Traps are required for every fixture.

## References

1. Kumar, S., *Building Construction*, Standard Publishers Distributors, 1705-B, Nai Sarak, Delhi-110006 (2005 Edition)
2. <https://civildigital.com/wp-content/uploads/2016/09/pile-foundation-design.jpg>
3. <https://i2.wp.com/civilblog.org/wp-content/uploads/2015/04/Pile-foundation-construction-under-water-using-tremie-method.jpg?fit=640%2C480>
4. <http://civiltraining.in/wp-content/uploads/2014/03/Types-of-pile-foundation.png>
5. <http://vcm.org.in/vcadmin/uploads/userfiles/images/raft-foundation.jpg>
6. <https://civil-engg-world.blogspot.com/2012/06/what-is-raft-foundation-difference.html>
7. <https://www.slideshare.net/NorozFiaz/mat-or-raft-foundation-62379976>
8. [https://www.slideshare.net/ved\\_ram/pile-foundations](https://www.slideshare.net/ved_ram/pile-foundations)
9. <http://www.civilengineeringx.com/foundations/pile-foundations>
10. <https://theconstructor.org/wp-content/uploads/2016/05/flemish-bond-brick-masonry>
11. <http://www.sweethaven02.com/BldgConst/Bldg02/fig0731>
12. <https://www.slideshare.net/nrlbhaskar/brick-masonry-26102621>
13. <http://www.civilengineeringx.com/building/bce/English-Bond>
14. [https://www.redrobinmasonry.com/wp-content/uploads/2015/10/tuck\\_pointing-1-1500x630.jpg](https://www.redrobinmasonry.com/wp-content/uploads/2015/10/tuck_pointing-1-1500x630.jpg)
15. [http://img.bhs4.com/98/8/9889D276B05892D7114DEA8279C1D1A76EE3B140\\_large](http://img.bhs4.com/98/8/9889D276B05892D7114DEA8279C1D1A76EE3B140_large)
16. [http://www.cement.org/images/default-source/contech/construction/joints\\_fig2.jpg?sfvrsn=a4b232bf\\_2](http://www.cement.org/images/default-source/contech/construction/joints_fig2.jpg?sfvrsn=a4b232bf_2)
17. [https://static.concretenetwork.com/photo-gallery/images/550x412Exact\\_0x4/site\\_26/portland-cement-association\\_38315](https://static.concretenetwork.com/photo-gallery/images/550x412Exact_0x4/site_26/portland-cement-association_38315)
18. <https://solminlabs.com/wp-content/uploads/2016/06/Coarse-Aggregate-1-1000x750>
19. <https://i2.wp.com/civilblog.org/wp-content/uploads/2014/09/Fineness-Modulus-of-Sand.jpg?fit=448%2C336>
20. <https://www.masterbuilder.co.in/wp-content/uploads/2017/06/Cement-powder-in-white-bag>