

ISSN 2072-0149

The AUST

Journal of Science and Technology

Vol. 3 No. 2 July 2011 (Published in January 2013)



**Ahsanullah University
of Science and Technology**

Editorial Board

Prof. Dr. Kazi Shariful Alam
Treasurer, AUST

Prof. Dr M.A. Muktadir
Head, Department of Architecture, AUST

Prof. A.Z.M. Anisur Rahman
Head, School of Business, AUST

Prof. Dr. Md. Anwarul Mustafa
Head, Department of Civil Engineering, AUST

Prof. Dr. S. M. Abdullah Al-Mamun
Head, Department of Computer Science & Engineering, AUST

Prof. Dr. Abdur Rahim Mollah
Head, Department of Electrical & Electric Engineering, AUST.

Prof. Dr. Mustafizur Rahman
Head, Department of Textile Engineering, AUST.

Prof. Dr. AFM Anwarul Haque
Head, Department of Mechanical and Production Engineering, AUST.

Prof. Dr. M. Shahabuddin
Head, Department of Arts & Sciences, AUST

Editor

Prof. Dr. Kazi Shariful Alam
Treasurer
Ahsanullah University of Science and Technology

Numerical Simulation of the Flexural Behavior of FRP-Strengthened Reinforced Concrete Beam

Sabreena Nasrin¹ and Mahbuba Begum²

ABSTRACT : *The rapid deterioration of concrete structure is becoming a challenge in the concrete industries worldwide. The use of fiber-reinforced polymer (FRP) is an efficient and technically sound method for strengthening the damaged concrete structures or upgrading the inadequately designed members or retrofitting of seismic damaged concrete structures. Although there is a large amount of experimental data available on the FRP strengthening of concrete structures, a full understanding of various debonding phenomena is somewhat lacking. As a contribution to fill this need a 3-D finite element model is developed in this study to investigate the flexural and FRP/concrete interfacial response of a FRP strengthened RC beams under two point loading. The numerical simulation is performed using ABAQUS finite element code. The performance of the numerical model is studied by simulating five experimental beams from published literature. The results showed that, the numerical model is capable of predicting the initial stiffness accurately. However, the ultimate capacity of the beams is not reached in the model due to numerical instability. More advanced solution techniques and contact simulations can be used to trace complete the load-displacement history of FRP strengthened RC beams under pure flexure.*

Keywords: *Flexural strength, Fiber-Reinforced Polymers (FRP), Load-deformation response, Reinforced Concrete (RC) etc.*

Introduction

The continual deterioration of various concrete structures has heightened awareness of the need for effective structural repair and rehabilitation procedures. A particularly challenging problem confronting engineers in the revival of the concrete structures is the rehabilitation of structural members. Externally bonded fiber reinforced polymers (FRPs) are the most efficient alternatives of conventional processes adopted for structural rehabilitation. Despite of high initial cost, the high strength to weight ratio, their resistance to corrosion, easy handling and installation processes are making them the best choice of materials for rehabilitation of RC structures, seismic damaged structures and so on. To increase the service life of the structure it is necessary to increase its load bearing capacity, repair damage or both (Bonacci and Maalej 2000). The need to rehabilitate the infrastructures is now under great concern as most of the bridges are getting deteriorated due to excess traffic loadings from design service load. The rapidly expanding body of literature in this area, along with the corresponding increase in level of activity, confirms the fact that these new materials are progressively gaining wider acceptance by the civil engineering community.(Buyukorturk and Hearing 1998; Nitereka and Neale 1999; Wu et al. 2007). New innovations regarding the development of design codes and limitations of codes are also taken under consideration.(Rizkalla et al.; Nitereka and Neale 1999).

Traditionally, the repair or rehabilitation of reinforced concrete beams has been achieved by bonding steel plates to the beams. Although this technique has proven to be reasonably effective, it has several distinct disadvantages: 1) susceptibility of the steel plates to corrosion and/or debonding; and 2) the weight of the steel plate may be excessive for long-span beams. In recent years, however, fiber reinforced plastic (FRP) plates have shown great promise as an alternative to steel plates for concrete beam repair/rehabilitation. In Bangladesh the use of FRP laminates is not introduced yet because of lack of knowledge about installation procedures, non availability of the FRPs and financial problem.

In recent years numerous experimental investigations have been carried out on the strengthening of reinforced concrete beams using externally bonded fiber-reinforced polymers (FRPs). (Ritchie et al. 1991; Shin and Lee 2003; Aidoo et al. 2006). The behavior of FRP-strengthened beams are relatively well understood from the experimental point of view. For such applications, it is now well known that despite the capability of achieving considerable increase in strength capacities, premature failure by FRP debonding often limit the effectiveness of the strengthening schemes(Brena et al.2003; Thomson et al.2004; Aprile et al.2006).It is obvious from the literature that much less attention has been paid to numerical studies of debonding in comparison to the wealth of experimental investigations.

One of the first analytical works on the behavior of FRP-strengthened beams is that represented by Ehsani and Saadatmanesh (1990). Their work was based on linear elastic analyses and was limited to the interfacial behavior before cracking. A more advanced approach, the layer by layer numerical model was subsequently adopted by other researchers to take into consideration the material nonlinearities of the concrete before and after cracking.(Takahashi et al.1997; Nitereka and Neale 1999), or to include the effect of tension stiffening (Ebead and Marzouk 2007).These analyses were

¹ Lecturer, Department of Civil Engineering, Ahsanullah University of Science and Technology, Dhaka

² Associate Professor, Department of Civil Engineering, Bangladesh University of Engineering and Technology, Dhaka

intended for the prediction of the load-deflection behavior and the ultimate load carrying capacities. However, they did not account for the possible debonding failure modes.

An attempt has been made to develop a complete Finite element model that can be applied for a variety of geometries of FRP strengthened beams subjected to two point loading to obtain accurate simulations of behavior (Fig.1). The model therefore is to be capable of simulating numerically the flexural behavioral on FRP strengthened RC beams. The model was developed using the ABAQUS/Standard (HKS 2003) finite element software code.

The main approach of this research work can be listed as,

- To simulate the flexural and interfacial behavior of FRP strengthened RC beams using finite element method.
- To validate the numerical model with respect to the experimental database available in the published literatures.

Finite Element Modeling

Modeling Parameters

Experimental results of 5 specimens, representing FRP-strengthened reinforced concrete beams are used to validate the numerical results (Brena et al., 2003 and Ross et al., 1999). To validate the model, simulations were conducted for two point loading beam test specimens reported in the literature, varying in cross section from 200×200 to 203×356 mm, including a variety of reinforcement ratio and bonded length. Variation of thickness of the FRP sheets was considered in the Finite Element Modeling.

The model also considered variable geometrical characteristics of the specimens and material properties for the concrete, steel reinforcement and FRP composites.

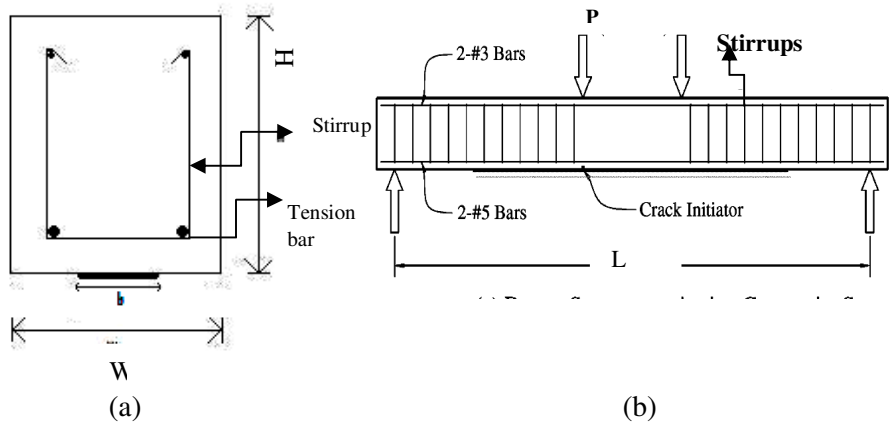

Figure 1: FRP strengthened beams: (a)cross section; (b) longitudinal section of beam.(Ross et al.,1999)

Table 1 and 2 represent the dimensions and different parameters for the beams, which corresponds to those tested by Brena et al.(2003) and Ross et al.(1999). The tables include five specimens out of which three beams; namely A1,A2 and A3 were modeled to investigate the influence of the dimensions of FRP laminates for a constant FRP laminate thickness. Rest two beams, B1,B2 of different steel reinforcement ratio were also modeled to validate the numerical results.

Table 1: Geometric Properties of the Reference Beams

Reference Beam	Beam Designation	Beam Dimensions (mm)			Steel reinforcement		FRP sheets		
		L	W	H	Longitudinal ratio		L(mm)	W(mm)	H(mm)
					Ten.	Trans.			
Brena et al. (2003)	A1	2690	203	356	0.56	ϕ 10(no.6 g wires)@102 mm	1068	50	.33
	A2						1272		
	A3						2084		
Ross et al. (1999)	B1	2742	200	200	0.46	ϕ 6 (no.3)@102 mm	2700	203	0.45
	B2				0.83				

Table 2: Material Properties of the Reference Beams

Reference Beam	Beam Designation	Concrete			Steel		FRP		
		f_c (MPa)	ϵ_{cu} %	E_c (GPa)	f_y (MPa)	E_s (GPa)	f_u (MPa)	E_F (GPa)	ϵ_{fu} %
Brena et al.(2003)	A1	35.1	0.0035	26.660	440	200	3790	230	1.6
	A2								
	A3								
Ross.et al.(1999)	B1	54.8	0.0035	34.500	410	200	2206	137.9	1.6
	B2								

In this 3-D study half of the reference beams were modeled to investigate the performance of the concrete damage plasticity model and contact algorithm in modeling the FRP-concrete interface and also to include the effect of different geometric and material properties along the height of the test specimens.

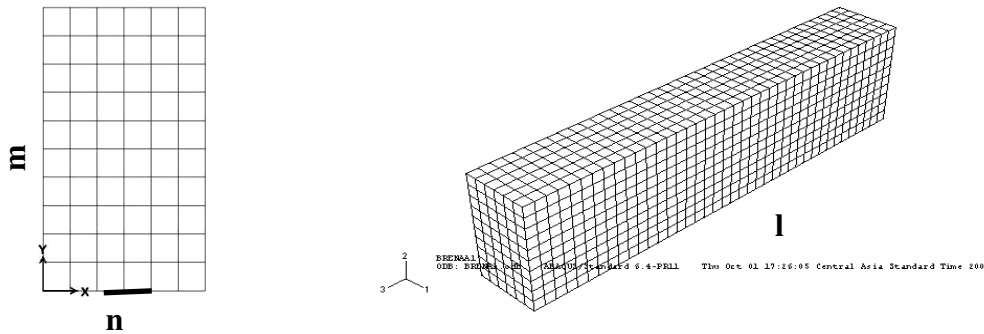

Figure 2: (a) Cross section (b) 3-D view of the beam mesh

In modeling as shown in Fig.3 eight node brick elements were used to model the concrete, two-node truss element were used to model steel reinforcement whereas four-node finite strain reduced integration shell elements are used to simulate the FRP sheets and laminates. The interface elements between the FRP and concrete nodes were aligned in the longitudinal direction of the beam with the assumption of full strain compatibility in the other two directions. The element sizes of the concrete were selected to be 33x35x33 mm rectangular block. The length of each interface element was also chosen as 33 mm representing the distance between each two adjacent FRP nodes.

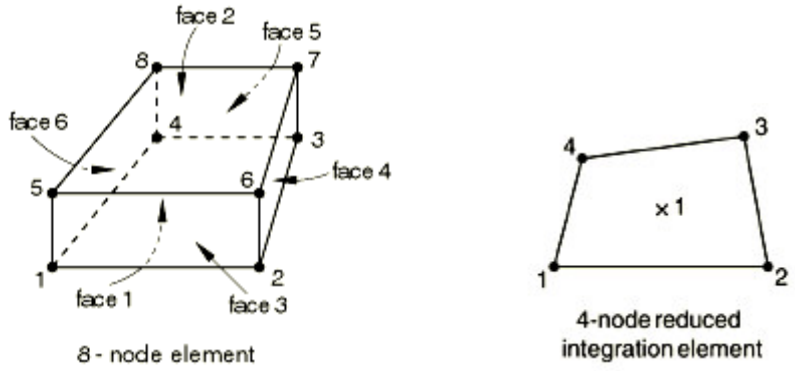

Figure 3: (a) 8-node element (b) 4-node reduced integration element

Steel is a ductile material which experiences large inelastic strain after yield point. The true stress and logarithmic strain graph which is so called hardening curve was considered for modeling the material behavior of steel (Fig.4)

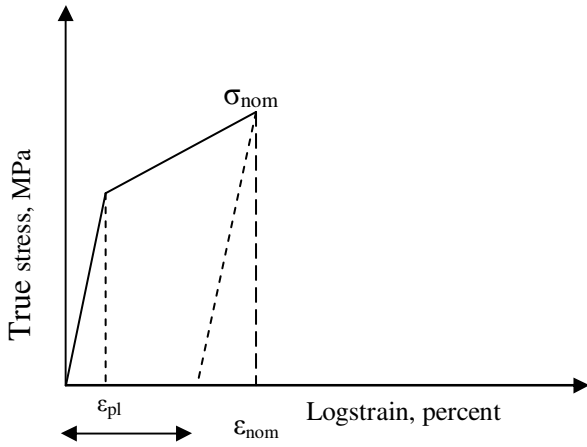

Figure 4: Hardening curve

A general form of serpentine curve, as given by Carrier and Chu (1985) was used to represent the complete stress-strain relationship of unconfined concrete (Fig.5).

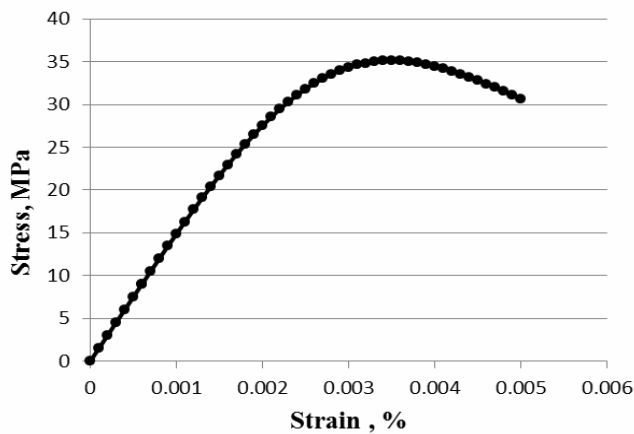

Figure 5: Stress-strain relationship curve of concrete

The properties of FRP laminate were modeled as an isotropic material using a linear elastic stress-strain curve (Fig.6).

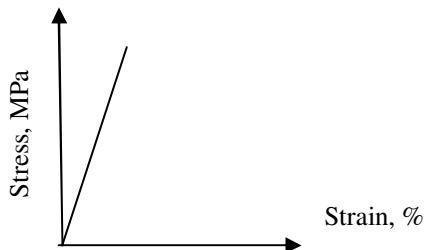

Figure 6: Stress-strain curve for FRP

The contact surface between the FRP laminates and concrete surface was modeled by the default Coulomb friction model provided by ABAQUS software. Small sliding was allowed in the interface.

The Coulomb friction model was applied to relate the maximum allowable frictional (shear) stress across an interface to the contact pressure between the contacting bodies to carry shear stresses up to a certain magnitude across their interface before they start sliding relative to one another; this state is known as sticking (Fig.7)

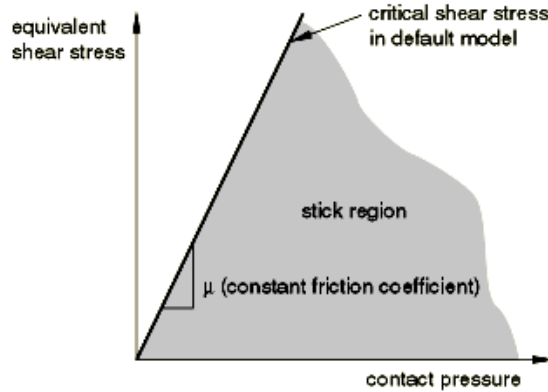

Figure 7: Stick regions for the basic Coulomb friction model.

Modeling Strategy

Two point loading was applied just like the experimental way. As we have modeled only half of the beams because of the symmetry so hinge support was applied in one end and conditions of symmetry are applied on the other end.

The solution strategy based on the Newton-Raphson method was used because of its rapid convergence towards the root. The method used an iterative process to approach one root of a function.

Results and Discussion

Numerical analyses were performed for 5 specimens of two different groups using the finite element model. The numerical load versus displacement behaviors are compared with the corresponding experimental results (Carriera and Chu (1985).

Fig.8–9 shows the numerically and experimentally obtained loads plotted against the displacements experienced by the beam sets of Brena et al.(2003). The load –displacement behavior is found satisfactory before starting cracks in the beams. After reaching the cracking point the numerical results start deviating from the experimental values. But the capacity of the beams couldn't be predicted from the numerical analyses.

Load vs Displacement curve

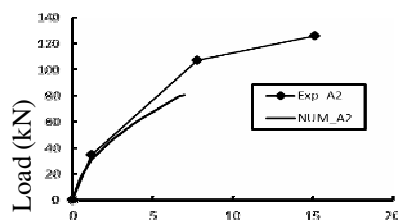
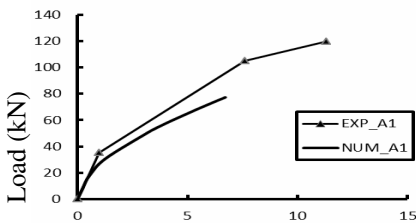

Displacement (mm)

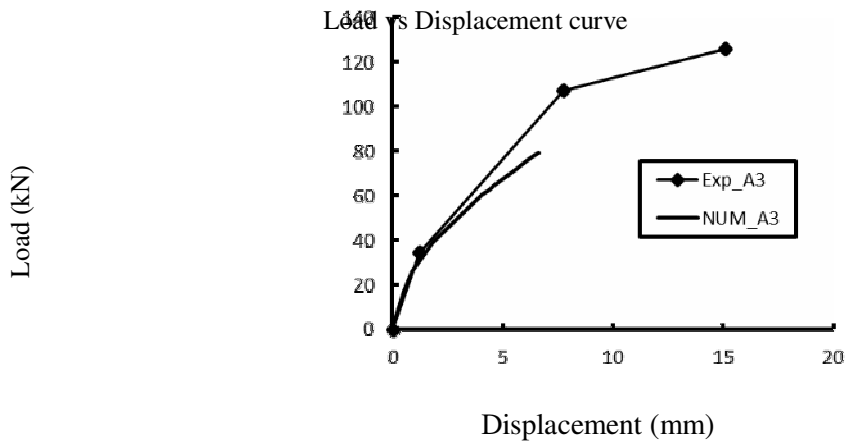

Figure 8: Experimental and numerical load versus displacement behavior for the beam A1, A2 and A3.

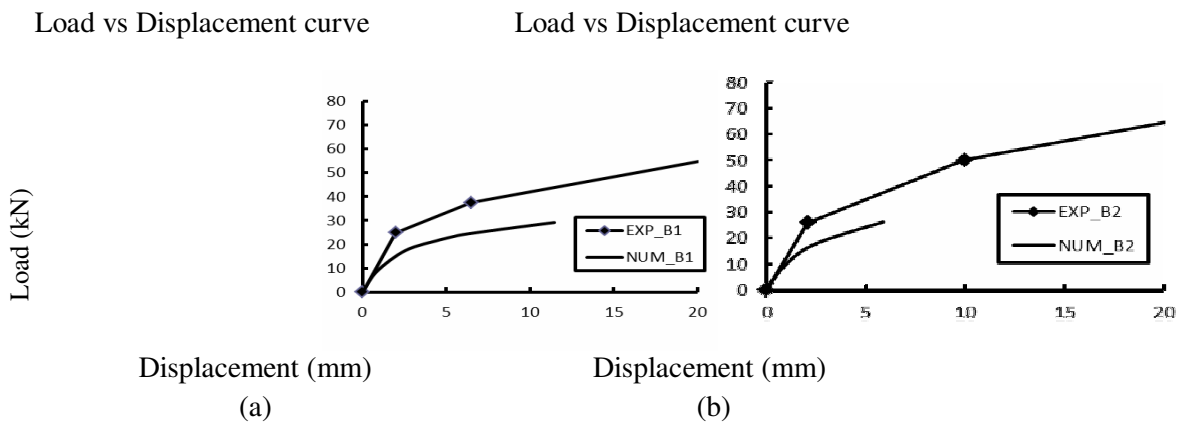

Figure 9 : Experimental and numerical load versus displacement behavior for the beam B1 (a) and B2(b).

From the above figures it is quite apparent that the 3-D finite element models are capable of predicting the initial stiffness very well. Though the steel reaches the yield point but the obtained load bearing capacity of the beams are less than the experimental value. Also the beams weren't able to reach peak load due to instability in solution technique. Beside this, the models have some limitations also such as

- FRP has been modeled considering it as an isotropic material.
- Perfect bonding is assumed between the concrete and steel.
- Interface between concrete and FRP surface has been modeled using the Coulomb-friction model which is not proper representative of the actual frictional behavior of the interfaces.
- Simple Newton-Raphson solution technique has been used in the numerical simulation. However, the behaviour of FRP strengthened RC beams is highly nonlinear in nature due to the presence of cracks in concrete and contact at the FRP and reinforced concrete.

Therefore, a more advanced solution techniques should be used to trace the load-displacement history of these beam.

Conclusion

The flexural behavior of FRP strengthened RC beams is studied with respect to the extensive experimental database available in the published literatures. Though a large amount of experimental data is available on the fiber-reinforced

polymer (FRP) strengthening of concrete structures but information about the debonding failure is somewhat lacking. A 3-D finite element model is developed using the ABAQUS finite element code to investigate the flexural and interfacial bond behavior of the FRP strengthened RC beams. The results showed that, the numerical model is capable of predicting the initial stiffness accurately but the ultimate capacity is not reached because of numerical instability. So more advanced solution technique should be used to identify the full load-displacement history of FRP strengthened RC beams.

Recommendations

For modeling a proper and more accurate 3-D finite element model the limitations of this work should be eliminated by

- Adopting more sophisticated solution technique to solve this highly nonlinear problem.
- Providing the orthotropic property of FRP laminates.
- Using more advanced contact algorithm to model the interface between FRP and concrete.

References

- Aidoo, J., Harries, K.A., and Petrou, M.F. (2006). "Full-scale experimental investigation of repair of reinforced concrete interstate bridge using CFRP material." *J. Bridge Eng.*, 11(3), pp350-358.
- Aprile, A., Manzoni, S., Benedetti, A. Ascoine, L., and Feo, L. (2006). "Flexural crack pattern on R/C beams strengthened with FRP plates." *Proc., 2nd Int. fib Congress (CD-ROM)*, Naples, Italy, Paper ID 10-38.
- Bonacci, J. F., and Maalej, M. (2000). "Externally bonded fiber-reinforced polymer for rehabilitation of corrosion damaged concrete beams." *ACI Structural Journal*, Title No.97-S71., V. 97, No. 5, September-October, pp 703-711
- Brena, S.F., Bramblett, R. M., Wood, S. L., and Kreger, M.E. (2003). "Increasing flexural capacity of reinforced concrete beams using carbon fiber-reinforced polymer composites" *ACI Structural Journal*, Title no. 100-S5, V. 100, No. 1, January-February, pp36-46.
- Buyukorturk, O., and Hearing, B. (1998) "Failure Behavior of Precracked Concrete Beams .
- Carriera, D.J., and Chu, K. H. (1985). "Stress-strain relationship for plain concrete in compression". *ACI Structural Journal*, Title no. 82-72, November-December, pp797-804.
- Ebead, U.A., and Neale, K.W. (2007). "Mechanics of fiber-reinforced polymer concrete interfaces." *Can.J.Civ.Eng.*, 34(3), pp367-377.
- Nitereka, C., and Neale, K.W. (1999). "Analysis of reinforced concrete beams strengthened in flexure with composite laminates." *Can. J. Civ. Eng.* 26: pp 646-654
- Niterika, C., and Neale, K.W. (1999). "Analysis of reinforced concrete beams strengthened in flexure with composite laminates." *Can.J.Civ.Eng.* 26(5), pp 646-654.
- Ritche, P.A., Thomas, D., Lu, L.W., and Conelly, G. (1991). "External reinforcement of concrete beams using fibre reinforced plastics." *ACI Structural Journal*, 96(2), pp212-219.
- Rizkalla, S., Hassan, T., and Hassan, N. (1998) "Design recommendation for the use of FRP as reinforcement and strengthening of concrete structures." pp1-33.
- Ross, C.A., Jerome, D.M., Tedesco, J.W., and Hughes, M.L., (1999). "Strengthening of reinforced concrete beams with externally bonded composite laminates." *ACI Structural Journal*, Title No.96-S23, V. 96, No. 2, March-April, pp 212-220
- Shin, Y-S., and Lee, C (2003). "Flexural behavior of reinforced concrete beams strengthened with carbon fibre-reinforced polymer laminates at different levels of sustaining load." *ACI Structural Journal*, 100(2), pp 231-239.
- Takahashi, Y., Sato, Y., Ueda, T., Maeda, T., and Kobayashi, A. (1997). "Flexural behavior of RC beams with externally bonded carbon fiber sheet." *Nonmetallic (FRP) reinforcement for concrete structures*. Vol. 1, Japan Concrete Institute, Tokyo, pp 327-334.
- Thomson, H., Spacone, E., Limkatanyu, S., and Camata, G. (2004). "Failure mode analysis of reinforced concrete beams strengthened in flexure with externally bonded fiber-reinforced polymers." *J. Compos. Constr.*, 8(2), pp123-131.
- Tulin, Leonard, G., and Grestle, K.H. (1964). "Discussion of the equation for the stress-strain curve of the concrete." *ACI Structural Journal*, 235-243. V. 61, No. 9, September, pp1236-1238.